

HUGO GERNSBACK, *Editor*

RADIO CRAFT

AND POPULAR ELECTRONICS

THE RADIO ROCKET
SEE PAGE 594



ALEX SCHÖNBURG

JULY
1944

25¢
CANADA, 30¢

RADIO-ELECTRONICS IN ALL ITS PHASES

Again Available

TO MEET MOST PRODUCTION SCHEDULES!



At WESTON, production finally has outstripped the overwhelming war demand for panel and other instruments . . . making WESTONS again obtainable on a basis to meet most war production schedules.

To experienced instrument users, this means they again can obtain the instruments whose design and manufacture incorporate the broadest instrument experience in surmounting the requirements of exacting applications. The instruments whose consistent, uniform performance simplifies their problems of inspection, handling and other burdensome procedure . . . and whose dependable, long-term accuracy assures better operating performance from the devices into which they're built.

Why not discuss your instrument schedules with WESTON, today . . . and be sure of obtaining the added product efficiency which authentic WESTONS provide.

Weston Electrical Instrument Corporation
618 Frelinghuysen Avenue, Newark 5, New Jersey

- Panel & Switchboard Instruments (DC, AC, and Thermo)
- Precision DC and AC Portables
- Instrument Transformers
- Specialized Test equipment
- Laboratory Standards
- Sensitive Relays
- Light Measurement Instruments
- Aircraft Instruments
- Electric Tachometers
- Dial Thermometers

FOR OVER 55 YEARS LEADERS IN ELECTRICAL MEASURING INSTRUMENTS

Be a RADIO Technician



J. E. SMITH, President
National Radio Institute

You Build These and Other Radio Circuits
with 6 Big Kits I Send!

By the time you've conducted 60 sets of Experiments with Radio Parts I supply, made hundreds of measurements and tests, you'll have **PRACTICAL** Radio experience valuable in a good full or part-time Radio job!



Superheterodyne Circuit, Preselector, oscillator-mixer—first detector, i.f. stage, diode detector— a.v.c. stage, audio stage. Bring in local and distant stations on this circuit which you build!

Measuring Instrument you build in Course. Use it in practical Radio work to make **EXTRA** money. Vacuum tube multimeter, measures A.C., D.C. and R.F. volts, D.C. currents, resistance, receiver output.



A.M. Signal-Generator. Build it yourself! Provides a mplitude-modulated signals for test and experimental purposes. Gives valuable practice!

I Trained These Men



\$10 a Week in Spare Time
"I repaired some Radios when I was on my tenth lesson. I made \$600 in a year and a half, and have made an average of \$10 a week—just spare time." JOHN JERRY, 1337 Kalamath St., Denver, Colo.



\$200 a Month in Own Business
"For several years I have been in business for myself making around \$200 a month. I have N.R.I. to thank for my start." A. J. FROEHNER, 300 W. Texas Ave., Goose Creek, Texas.

Get Into a Busy Field with
a Bright Peacetime Future

I Train Beginners at Home for Good Spare Time and Full Time Radio Jobs

Here's your opportunity to get a good job in a busy field with a bright peacetime future! There is a shortage today of trained Radio Technicians and Operators. So mail the Coupon and I'll send you a Sample Lesson from my Radio course **Free**. At the same time I'll send you my 64-page, illustrated book, "Win Rich Rewards in Radio." It describes many fascinating types of Radio jobs, tells how N.R.I. trains you at home in spare time—how you get practical experience building and testing Radio Circuits with **SIX BIG KITS OF RADIO PARTS** I send!

More Men I Trained Now Make \$50 a Week Than Ever Before

Keeping old Radios working is booming the Radio Repair business. Profits are large after-the-war prospects are high, too. Think of the new boom in Radio Sales and Servicing that's coming when new Radios are again available—when Frequency Modulation and Electronics can be promoted—when Television starts its postwar expansion!

Broadcasting Stations, Aviation Radio, Police Radio, Loudspeaker Systems, Radio Manufacturing, all offer good jobs now to qualified Radio men—and most of these fields have a big backlog of business that has built up during the war, plus opportunities to expand into new fields opened by wartime developments. You may never see a time again when it will be so easy to get a start in Radio!

Many Beginners Soon Make \$5, \$10 a Week EXTRA in Spare Time

The day you enroll for my Course I start sending you **EXTRA MONEY JOB SHEETS** that help show how to make **EXTRA** money fixing Radios in spare time while still learning. I send you **SIX** big kits of Radio Parts as part of my Course. You **LEARN** Radio fundamentals from my illustrated, easy-to-grasp lessons—**PRACTICE** what you learn by building real Radio Circuits—**PROVE** what you learn by interesting tests on the circuits you build!

Find Out What N. R. I. Can Do For YOU

MAIL THE COUPON for a Sample Lesson and my 64-page book **FREE**. My book, "Win Rich Rewards in Radio," is backed with facts—things you never knew about opportunities in Broadcasting, Radio Servicing, Aviation Radio, other Radio fields. Read the details about my Course—"50-50 Training Method"—4 Experimental Kits—**EXTRA MONEY JOB SHEETS**. See the fascinating jobs Radio offers and how you can train at home. Read many letters from men I trained telling what they are doing, earning. No obligation. Just MAIL COUPON in an envelope or pasted on a penny postal—J. E. SMITH, President, Dept. 4GX, National Radio Institute, Washington 9, D. C.



Broadcasting Stations employ N.R.I. trained Radio Technicians as operators, installation, maintenance men and in other capacities and pay well.



Fixing Radios pays many N.R.I. trained Radio Technicians \$50 a week. Many others hold their regular jobs and make \$5 to \$10 a week **EXTRA** fixing Radios in spare time.

Sample Lesson FREE

I will send you a **FREE** Lesson, "Getting Acquainted with Receiver Servicing," to show you how practical it is to train for Radio in spare time. It's a valuable lesson. Study it—keep it—use it—without obligation! Tells how "Superhet" Circuits work, gives hints on Receiver Servicing, Locating Defects, Repair of Loudspeaker, I.F. Transformer, Gang Tuning Condenser, etc. 81 illustrations. Get your sample lesson **FREE**—mail Coupon NOW!

**TELEVISION
ELECTRONICS
FREQUENCY MODULATION**
My up-to-date Course includes training in these new developments.

OUR 30TH YEAR OF TRAINING MEN FOR SUCCESS IN RADIO

GOOD FOR BOTH 64 PAGE BOOK SAMPLE LESSON FREE

J. E. SMITH, President, Dept. 4GX
National Radio Institute, Washington 9, D. C.

Mail me **FREE**, without obligation, a Sample Lesson and your 64-page book: "Win Rich Rewards in Radio." (No salesman will call. Write plainly.)

Name Age

Address

City State





MEMBER
AUDIT BUREAU OF CIRCULATIONS

HUGO GERNSBACK, *Editor-in-Chief*
FRED SHUNAMAN, *Associate Editor*
I. QUEEN, *Technical Associate*
A. PASCALE, *Production Manager*
G. ALIQUO, *Circulation Manager*
JOHN J. LAMSON, *Advertising Director*
ALFRED STERN, *Promotion Manager*

IN THE NEXT ISSUE

How to Measure Inductance
Radio Receivers of 1904
The Electron Microscope
A Homebroadcasting Set
Power Packs Without Iron
Stage-by-Stage Testing

Published by Radcraft Publications, Inc.
Publication Office: 29 Worthington
Street, Springfield 3, Mass.

Editorial and Advertising Offices: 25
West Broadway, Tel. RE2-9690, New
York 7, N. Y.

Chicago Advertising Office: Radio-Craft,
520 North Michigan Avenue, Tel. Su-
perior 7306, Chicago 11, Ill.

Cleveland Advertising Office: 405 Erie
Bldg., Cleveland, Ohio. Burdette Phil-
lips, Manager, Tel. Main 9645.

RADIO-CRAFT is published monthly,
on the 25th of the month preceding that
of date; subscription price is \$2.50 per
year in U. S. (In foreign countries, 75c
additional per year to cover postage;
Canada, 50c additional.) Special rates
for members of the Armed forces in
U. S. or those addressed by A.P.O. or
F.P.O. mail, \$2.00. Entered at the post
office at Springfield as second-class mat-
ter under the Act of March 3, 1879. All
communications about subscriptions
should be addressed to: Circulation
Manager, Radio-Craft, 29 Worthington
St., Springfield 3, Mass.

Notice of CHANGE of ADDRESS should
reach us at least one month in advance. When
ordering a change, please furnish an address
stencil impression from a recent wrapper if
you can. Address changes cannot be made
without the old address as well as the new.

Foreign Agents

London—Atlas Publishing and Distributing
Co., Ltd., 18 Bride Lane, Fleet St., London,
E.C. 4.

Melbourne—McGill's Agency, 179 Elizabeth
St., Australia.

Text and illustrations of this magazine are
copyright and must not be reproduced without
permission of the copyright owners.
Copyright, 1944, Radcraft Publications, Inc.

Contents July, 1944 Volume XV, No. 10

Editorial: Your Post-War Radio.....	by Hugo Gernsback	585
Radio-Electronics Monthly Review.....		586
U. S. Owes Debt to Radio "Hams".....	by Larry LeKashman	601

ELECTRONICS

X-Ray Diffraction.....	by Fred Shunaman	588
Industrial Electronics, Part V.....	by Raymond F. Yates	592
Practical Electronics, Part IV.....	by Fred Shunaman	595
Better Television Coming?.....	by A. Pascale	596
So You Think You Know Electronics!.....		600
Cathode-Ray Tubes.....	by Nathaniel Rhita	604
Ceilometer.....		606
Check Your Sun-Tan Electronically.....		628

WARTIME RADIO

The Radio Rocket (Cover Feature).....	by Hugo Gernsback	594
---------------------------------------	-------------------	-----

CONSTRUCTION

Signal Tracer.....	by John F. Coolen	591
Power for Portables.....	by R. S. Havenhill	598
Treasure Locators.....	by John Haynes	607
"Tom Thumb" Radio.....	by Edwin Bohr	609

RADIO TRAINING

Measuring Capacity.....	by I. Queen	602
-------------------------	-------------	-----

SOUND

Shipyards Uses Sound.....	by J. T. Rathke	590
---------------------------	-----------------	-----

SERVICING

Tube Price Ceilings.....		610
--------------------------	--	-----

DEPARTMENTS

World-Wide Station List.....	Edited by Elmer R. Fuller	608
Progress in Invention.....	Conducted by I. Queen	612
New Radio-Electronic Devices.....		614
Question Box.....		616
Try This One!.....		618
Available Radio-Electronic Literature.....		619
Radio-Electronic Circuits.....		620
Technotes.....		634
The Mail Bag.....		636
Book Reviews.....		639

ON THE COVER

A method of increasing the accuracy of the new rocket weapons is shown on our cover this month. A small transmitter and receiver are installed in the rocket; signals are picked up by a device similar to a gun-control unit which then corrects the flight by means of a receiver in the rocket, insuring that it hits the target.



FIRST ON THE NORMANDY COAST

The Army's SCR-299's went ashore with the wave of Allied assault troops that split the 2nd front wide open. These mobile radio units rolled up on the beachhead early in the battle to serve as vitally important front line communications weapons to coordinate and direct the striking power of the land, sea and air forces. . . . In truck or duck, the Hallicrafters-built SCR-299's go anywhere and are sturdy enough to withstand front line action. Highly dependable and powerful, they "get the message through."

hallicrafters RADIO

THE HALLCRAFTERS CO., MANUFACTURERS OF RADIO
AND ELECTRONIC EQUIPMENT, CHICAGO 16, U. S. A.



BUY A WAR
BOND TODAY!



THE FOURTH REASON

The men and women of Hallicrafters Company are proud to receive the Fourth Army-Navy Production Award. It is a Fourth Reason, a Fourth Incentive, to continue to produce the most and the best that those at the fighting fronts all over the world shall not have "too little, too late." With deep humility and with the realization that to produce is the least that can be done for those who fight, the people of Hallicrafters accept this award.

BUY A WAR BOND TODAY!

hallicrafters RADIO

THE HALLICRAFTERS COMPANY, CHICAGO 16, U. S. A.

THE FIRST EXCLUSIVE RADIO MANUFACTURER TO RECEIVE THE "E" AWARD FOR THE FOURTH CONSECUTIVE TIME



Meissner's own recreation center clearly illustrates two basic interests in Mt. Carmel life. Here a group of skilled electronics technicians from the Meissner plant is pictured in the midst of a gay Cole Porter hit.

MUSIC — AND ELECTRONICS

MAKE MT. CARMEL FAMOUS—

"The Little City of Great Music" — that's how neighboring cities describe Mt. Carmel, Illinois. And to this honor, in recent years, Mt. Carmel has added a world-wide reputation for precision-built radio parts and vital electronics war equipment. These come from the busy Meissner Plant.



Hundreds like these workers form the famous Meissner "precision-el." Most of them have literally grown up in the business of making superb electronics equipment.



Few hands can match them! You can tell at a glance that this man knows his trade. He is one of many reasons why Meissner products are always dependable, always first choice with men who know.



Superior Performance

Good news! You can now obtain a quantity of the highly popular Meissner "Plastic" I. F. Transformers. Particularly suitable for small receivers — where space is at a premium, yet superior performance is required. Famous for stability, high gain, wide range and double tuning. Typical of Meissner precision building, they are only $1\frac{1}{4}$ " square x $2\frac{1}{4}$ ", yet are not affected by temperature, humidity, vibration. Specially served Litz wire! One-piece molded plastic coil-form and trimmer base!



MEISSNER

MANUFACTURING COMPANY • MT. CARMEL, ILL.
ADVANCED ELECTRONIC RESEARCH AND MANUFACTURE

Sound the Alert!

MANAGEMENT LABOR

—for the 5th War Loan drive during June and July. The need for the 5th War Loan is immediate, crucial. For impending events may make the 5th the supreme financial effort of the war.

The U. S. Treasury has set the overall goal at \$16,000,000,000 — \$6,000,000,000 from individuals alone. This is the biggest sum ever asked of the American people—and it must be raised.

That's why the U. S. Treasury asks Management and Labor to sit down together and organize—NOW!

For organization—good organization—has been responsible for the excellent showing of the payroll market. And its most important single superiority has been personal solicitation—desk to desk,

bench to bench, machine to machine personal solicitation. 71% of all persons on payroll deductions were solicited for the 4th War Loan.

Now, to personal solicitation, add the sales incentive of a definitely established plant quota. Build your campaign around a quota plan. Set up departmental goals. Stress percentage of participation figures. Stimulate group enthusiasm.

In planning your quota campaign, work in close cooperation with the Chairman of your War Finance Committee. Everything is set to make the 5th War Loan drive a huge success—with your help!

(Note: You've read this message. If it doesn't apply to you please see that it reaches the one person who can put it in action!)

Here's the Quota Plan:

1. Plant quotas are to be established on the basis of an average \$100 cash (not maturity value) purchase per employee.
2. Regular Payroll Savings deductions made during the drive accounting period will be credited toward the plant quota.
3. 90% of the employees are expected to contribute toward raising the cash quota by buying extra 5th War Loan Bonds: 1—Outright by cash. 2—By extra installment deductions. 3—By extra installment deductions plus cash.

Example: JOHN DOE Mfg. Co. — 1,000 Employees
 1,000 employees x \$100 = \$100,000 Cash Quota
 Regular Payroll deductions during the eight weekly payroll Accounting Periods of June and July = 30,000
 \$70,000 (to be raised by sales of extra Bonds to at least 900 employees)

ORGANIZE

SOLICIT

DELIVER



The Treasury Department acknowledges with appreciation the publication of this message by

RADIO-CRAFT

This is an official U. S. Treasury advertisement—prepared under the auspices of Treasury Department and War Advertising Council.

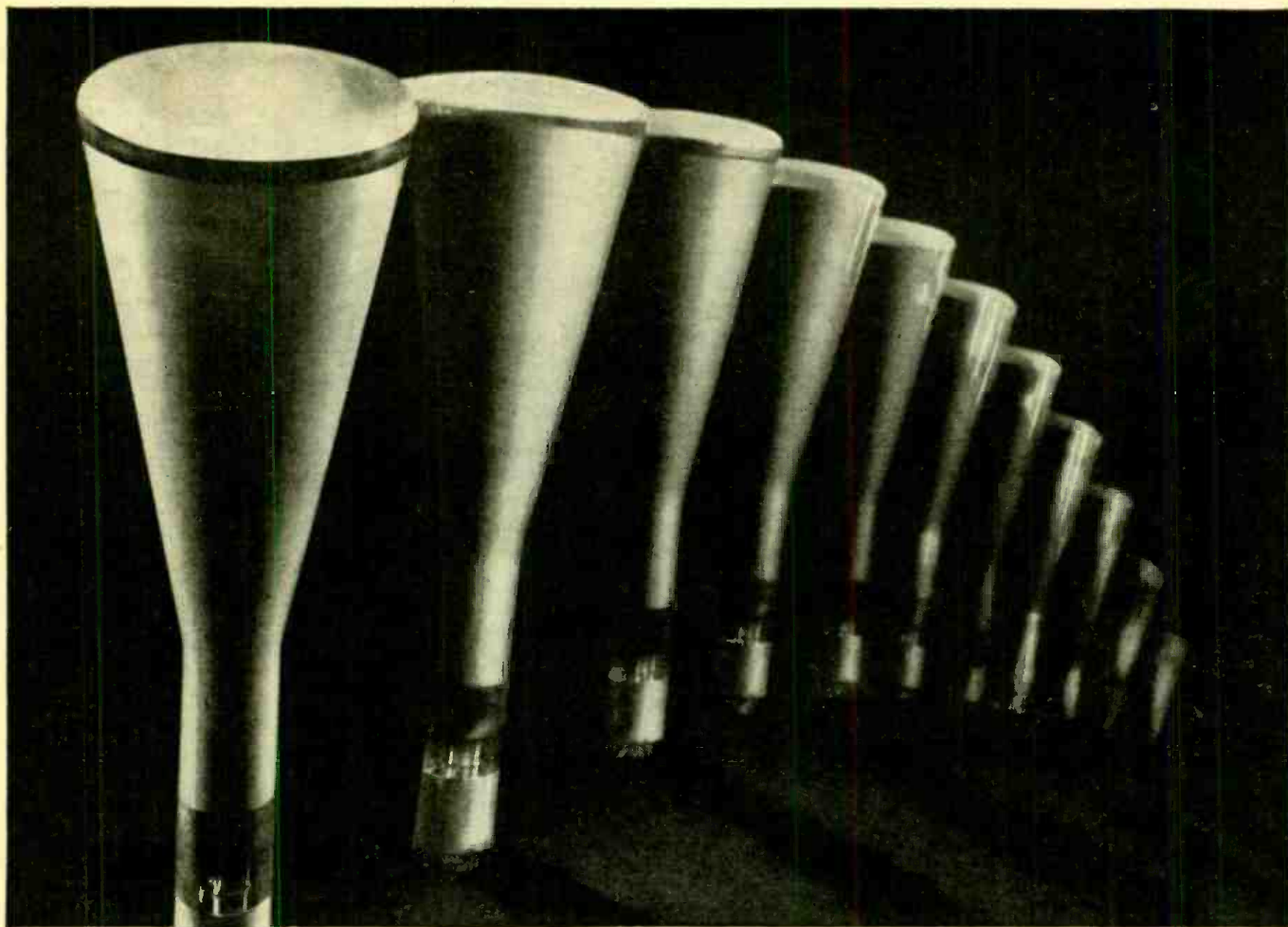

GOOD NEWS FOR TELEVISION!

Since National Union established new production records on cathode-ray tubes—the dream of low-cost television for the average post-war home has taken a long step toward fulfillment.

Consider the fact that National Union has succeeded in raising its cathode-ray tube production to a volume many times greater than the combined pre-war C-R tube output of the entire industry! To achieve such a production miracle required, of course, completely new techniques, new mechanical aids to operators, new quality control measures. But above all, it required imagination and technical capacity to cut loose from the long prevalent conception that the manufacture of cathode-

ray tubes was strictly a laboratory project. N. U. engineers proved that these laboratory techniques *could* be adapted to high speed streamline mass production. And, it is significant that N. U. C-R tubes have acquired at the same time an international quality reputation, with special distinction for their superior fluorescent screens.

National Union success in producing better television tubes at economical cost—is especially good news for servicemen now looking to television as a major source of post-war income. Remember to *count on* National Union.

NATIONAL UNION RADIO CORPORATION, NEWARK, N. J.
Factories: Newark and Maplewood, N. J.; Lansdale and Robeson, Pa.



NATIONAL UNION

RADIO AND ELECTRONIC TUBES

Transmitting, Cathode Ray, Receiving, Special Purpose Tubes • Condensers • Volume Controls • Photo Electric Cells • Panel Lamps • Flashlight Bulbs



Television sees Democracy in Action

● AMERICANS have always been eager to share in the political life of our Democracy. This year, the two great political conventions will be filmed in Chicago and the reels will be rushed to New York for broadcasting over WNBTV, NBC's pioneer television station.

Four years ago, in 1940, WNBTV made television history, by directly telecasting the Republican Convention at Philadelphia and by broadcasting films of the Democratic conclave in Chicago.

When Peace comes, a greater and more widespread television audience—expanding into mil-

lions of homes equipped with RCA television—will see as well as hear Democracy in action . . . thanks to the new super-sensitive television camera, and other radio-electronic devices developed in RCA Laboratories.

Today, RCA research and engineering facilities are devoted to creating the best possible fighting equipment for the United Nations. Tomorrow, RCA—Pioneer in Progress—looks forward to supplying American broadcasters, and the American public, with still finer radio, television, and electronic instruments.



RADIO CORPORATION OF AMERICA
RCA LABORATORIES • PRINCETON • NEW JERSEY

RCA
leads the way in
radio—television—
phonographs—records—
tubes—electronics



Listen to RCA's "The Music America Loves Best"—Saturdays, 7:30 P.M., E.W.T., over the Blue Network ★ BUY WAR BONDS EVERY PAY DAY ★

Your Post-War Radio

. What will be the nature of post-war radios? . . . Will they be of the pre-Pearl Harbor variety? . . . Will they be of the glittering types the post-war advertisements have pictured?

HUGO GERNSBACK

ONCE more it seems necessary to bring some light into the confusion rampant in popular opinion as to post-war radio sets.

It is unfortunate that American radio set manufacturers have so far not been able to agree on any uniform policy in respect to post-war radios, but there is a very good reason for that, too. The reason is found chiefly in the following two points:

(1) Complete uncertainty as to when the war will be terminated; (2) the amount of radio progress there will be during the war period.

While it is true that practically all of the larger radio manufacturers have "models" of post-war radios, it is also true that these models are at best only uncertain and incomplete blueprints. As soon as one model is made, another one takes its place, because some new feature has been added which necessitated the later one. This may be expected to go on indefinitely until the war is finally won.

One thing is certain—the large manufacturers will not go back to the 1942 type of radio set. There will be a certain amount of confusion when some smaller manufacturers, hungry for business, will begin turning out midgets and other 1942 types of radio sets as soon as materials become available, but such sets can be considered only as a stop-gap. Incidentally, such sets, if they should be manufactured in large quantities, are bound to do a dis-service to the radio industry. If millions of radio-hungry people buy such sets, they will find them obsolete in a very short time. Moreover, their trading-in value will be practically nil.

This is not a healthy situation to look forward to, but it is something that cannot be helped. There is no law whereby small radio manufacturers can be stopped from manufacturing practically obsolete types of radio receivers.

Another factor of uncertainty is the often used term "end of the war". There are two camps in the United States, both interpreting the end of the war in different

terms. One camp considers that when Germany is finally knocked out of the struggle that this will be the end of the war. They consider that once that is accomplished, a sufficient amount of strategic materials will be freed so that all manufacturers can begin to run their factories full blast, building radio receivers for the civilian trade. Indeed, many manufacturers feel that by about the middle of 1945, with Germany out of the way, America will go back to a peace-time basis.

Informed authorities do not share this view because they feel that of the two enemies, Japan will be the more difficult to subdue, and while it may be true that as the war proceeds certain materials will be released for civilian consumption, the amount will not be sufficient to permit mass production of civilian radios. Japan, too, has to be put out of the war, and this I feel sure will not happen until way into 1946, if then.

It is easy to see if you consider only these points how difficult it becomes to forecast the post-war radio trends. Added to this are other factors which further becloud the issue.

Radio war progress has been tremendous. There have been many new inventions, many new procedures—all of which are now used for the war effort. Not all of them can be translated into post-war radio, but many of them will be adopted. Every month brings new radio ideas and new radio developments. Hence it is wholly impossible to even think of freezing a radio design or a radio set now.

At this particular time, however, it is possible to make a very rough guess at the main features of the post-war radio set, but it must be admitted and realized that what is said here is only in the light of the *present* state of the radio art. That state will, without a doubt, change every few months.

What then will be the popular post-war radio receiver as seen from this vantage point?

For the past few years the American public has been acutely phonograph record-. (Continued on page 638)

Radio Thirty-Five Years Ago

In Gernsback Publications

FROM the July, 1909, issue of MODERN ELECTRICS:

Dr. Branly's New Apparatus, by A. C. Marlowe (account with a number of photographs showing radio remote control experiments including steering torpedoes by wireless).

Wireless in China.
Guiding Vessels at Sea.
Pictures by Wireless.
Wireless Airship Control.
Airship Orientation by Wireless.

HUGO GERNSBACK	
Founder	
Modern Electrics	1908
Electrical Experimenter	1913
Radio News	1919
Science & Invention	1920
Radio-Craft	1929
Short-Wave Craft	1930
Wireless Association of America	1908

New Tungsten Oscillation Valve Antennae, by Greenleaf W. Pickard.
Wireless Stations About New York

(The radio station at the Plaza Hotel).
Recent Developments in Aerophony, by Lee De Forest.

"The Wireless Screech."
In the advertising department the following interesting items are found:
"R-J" Variometer by the Radio Telephone Company of New York.

A Receiving Set with a 3,000 meter double-slide tuner, detector-condenser, all mounted on a single base, advertised by W. J. Murdock of Chelsea, Mass.

AN ELECTRONIC blind landing instrument which guides pilots back to their home airfields and enables them to hit runways "on the nose" even when they are blacked out by war or weather, is in production at Westinghouse. These cross pointer indicators are now being built into combat planes and trainers.

Military sources report countless instances of blind landings where air crews have saved themselves by using this visual dashboard instrument for guidance during their hazardous last mile earthward. Some of these sources report landings in which pilots were able to "touch down" on the unseen field within fifty feet of the pre-selected spot.

Little information on the electronic features of the instrument can be released during wartime. It is stated merely that it virtually translates directional radio signals which furnish continuous vertical and lateral guidance to the runway when visibility is bad—"so bad that the pilot cannot see beyond the wing tips of his ship."

Described as "the most practical blind landing indicator so far developed," the instrument not only assures accuracy and speed—both essential to a pilot trying to set his ship down safely on an unseen runway—but it frees him of such mechanical encumbrances as headphones, slide-rule, and paper-and-pencil work, such as must be utilized with earlier systems or when making a blind landing by dead reckoning. With the instrument system, the pilot gets all directions for descent merely by watching

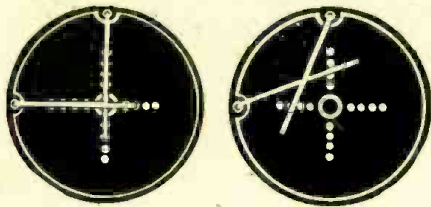

Left: Position of pointers when on course; Right: Position if plane is up and to the left.

two crossed pointers and two signal lamps on his instrument panel. Commercial pilots say the day is in sight when this system for landing will prevent cancellation of 90 per cent of flights now delayed because weather conditions at the airport of destination would prevent a safe landing.

The plane itself is equipped with two radio "landing" receivers which are tuned to the directional beams issued by the ground equipment. One receiver, responsive to the "localizer" or on-course beam, moves the vertical pointer on the instrument dial.



Appearance of the instrument out of its case.

Radio-Electronics

Items Interesting

The second receiver, which responds to altitude signals, operates the horizontal pointer.

Four separate radio transmitting stations and two antenna systems at and near the airport comprise the ground radio equipment. They shoot beams which first indicate the pilot's approach to the field and then mark the field's boundary; establish the invisible glide path which leads to the runway; and signal directions for keeping the glide to the field neither too shallow nor too steep.

Vertical guidance—to maintain the position of the plane in relation to the runway—is provided by three of these transmitters.

One furnishes the "glide path," a radio beam which can be compared to the funnel-shaped ray thrown by a flashlight. The other two transmitters are "markers" whose beacons, transmitted vertically, light the lamps on the pilot's instrument panel via the plane's "marker" receivers. The first flash tells the pilot he is a few miles from the airport and he should prepare for the glide path by maintaining an altitude of 1500 feet. When a similar beam from the second marker lights the other lamp the pilot knows he has reached the boundary of the field.

The homing path, or "localizer," is produced by ultra-high frequency radio transmitters feeding a pair of sharply directional antenna systems, consisting of two loops.

Signal strength emanating from the loops is almost equal if the plane is on course—"flying in" directly between them. This the vertical pointer of the instrument interprets by assuming an upright position. Should the plane wander to the left or right of the course, the corresponding signal predominates, causing the vertical pointer to veer in that direction, and in an amount roughly proportional to the distance the ship has flown off course.

The horizontal pointer remains in position—across the center of the dial—so long as the plane is "chuting" earthward at the correct angle. If the glide is too shallow, the pointer rises; if it is too steep, the pointer moves downward.

Though it is not strictly a "war baby," the instrument has proved its value in the crucial tests of aerial warfare. It is the result of seven years' continuous research and development by the Westinghouse Electric and Manufacturing Company and the Washington Institute of Technology, which worked with the U. S. Navy to originate a simplified device for taking the guesswork out of blind landing.

A NEW commercial license has been granted to the DuMont Television Station in New York City. The station, formerly W2XWV, is now known as WABD. The change is not expected to alter the station's policy of furnishing time free of charge to advertising agencies and others for their experimental programs, as a means of furthering the progress of television.

MILITARY requirements of electronic equipment may start tapering off by August, according to a bulletin put out last month by the War Production Board. The report stated that March output of communication and electronic equipment continued one per cent above the February level of production, and met the rising schedule. Radio—a declining program—ran above the production plan by one per cent. One of the chief difficulties in the production program is the shortage of transformers. During the next few months, schedules will rise steeply for airborne electronic equipment, nearly doubling by June, because of the previously announced 1944 aircraft program.

SIXTY good jobs are open for radio electricians on the 7,000 miles of civil airways in Alaska, Civil Aeronautics Administration officials announced.

A recent newspaper story describing jobs for man and wife teams as Aircraft Communicators in Alaska resulted in such a flood of applications that the CAA has cried "Uncle." But the radio electrician jobs, equally attractive, are still unfilled, and by July 1, the CAA hopes to sign up 60 applicants.

The jobs pay approximately \$3,475, which is made up of \$2300 base pay, plus the 25% differential for foreign service, plus the usual 21% overtime now paid government employees on the 48-hour week.

For more highly skilled radio men, the CAA has jobs which pay up to \$4600, and ten radio engineers are needed for which the annual salary is from \$3700 to \$5600.

Only draft exempt men can be considered, and applicants must have a release from their employer or from the War Manpower Commission, and a medical certificate. Men over 38 are acceptable, and discharged service men are given preference.

Applications should be sent to the Alaska Projects Depot, 224 Westlake Avenue North, Seattle, Washington, where transportation to Alaska is provided for accepted applicants.

DISSOLUTION of the Army-Navy Electronics Production Agency was announced last month by Chairman of the Committee on Civil Service, Representative Robert Ramspeck.

The agency was established as a joint separate operation of the War and Navy Departments in October, 1942, to clarify the situation then existing in the production and procurement, by the two services, of electronic equipment.

It is understood that the functions of Army-Navy Electronics Production Agency will be re-distributed to appropriate elements of the Army and the Navy and particularly to the WPB, where the greater part of the duplication was found by the investigators. It is stated on responsible authority that a small number of technically qualified consultants and other employees of Army-Navy Electronic Production Agency may also be transferred to the WPB.

Monthly Review

to the Technician

ABSIE the American broadcasting station in Europe, started to "present the American point of view" to the people of occupied Europe on Sunday, May 28.

The new station includes 12 transmitters. Programs will be broadcast on 267 and 307 meters (1124 and 978 Kc.) for 8½ hours daily. Short-wave programs are broadcast through four outlets at favorable times. More than 90 Americans are employed in operating the new station.

Languages used include Danish, Dutch, Belgian, Norwegian, French, German and English, which latter is described by the OWI as the secondary language of many Europeans. The new station is part of the psychological pre-invasion campaign, according to OWI sources. When invasion is under way, the usefulness of the station suffers no diminution, but rather increases, as the station is used for invasion instructions to the peoples of occupied areas.

The signature of the American station is the tune, "Yankee Doodle," played in a low, insistent key.

The Germans are making unprecedented efforts to jam the newly-inaugurated American Broadcasting Station in Europe, cluttering its five frequencies with whistles, bells, warbling, music and noise which sound like a cross between a tank factory and a rifle range.

Brewster Morgan, formerly with CBS, who now heads the OWI radio section in London, said the high-pressure jamming indicates the Nazis were badly worried over how the new station would be used.

Since the enemy's jamming facilities are limited, the all-out effort to block ABSIE's message to the people of Europe is allowing British Broadcasting Corporation transmitting to operate relatively free from interference for the first time in years, Morgan said.

T. A. M. CRAVEN of the FCC has resigned from his office, the resignation taking effect June 30. In a letter to the President tendering his resignation, he stated that he wished to be free to enter private business. The White House reply to him reads, in part:

"The reasons you cite leave me no alternative. I shall, therefore, comply with the request you make and I sincerely hope that your reentry in the field of private business will bring to you rewards that will more than recompense for the years of sacrifice and labor you have given your government."

Craven will be remembered as a staunch friend of the National Association of Broadcasters and the big networks, and more than once was in opposition to the rest of the Commission when decisions affecting these bodies were made.

Commissioner Craven stated that he plans to become associated in a technical capacity with the Cowles interests. The Cowles are publishers of newspapers in Des Moines and Minneapolis and LOOK magazine, as well as licensees of radio broadcasting stations.

DEMAND for between 20,000,000 and 25,000,000 radio receiving sets will exist by the end of 1944, as compared with the industry's all-time high production of 13,000,000 units in 1941, it was estimated last month by Larry E. Gubb, chairman of the board of directors of Philco Corporation.

In addition to the normal replacement demand for radio sets, FM will become increasingly important in the post-war years, Mr. Gubb said. "Until a few months ago, we were not too enthusiastic about FM. Only a few FM stations, mostly of low power, were on the air, and the number of FM programs was very limited. This whole picture was radically changed in January when the major broadcasting chains announced an entirely new policy of making their top-hit programs available to the FM audience and suggested to the owners of network stations that they apply for FM transmitting licenses to be ready for post-war. This new policy will have far-reaching effects as soon as the material situation eases to the point where new transmitters can be built.

"The greatest application of all for electronics is television," Mr. Gubb continued. "The rate at which television will grow in the next few years is somewhat a matter of conjecture. Some groups think it will progress slowly at first, others believe much more rapidly. The significant fact is that the revenues from television, whether they become large immediately after the war, or over a period, will add further to the proven earning power of the well-established radio companies.

"In any projection of television's future. I am reminded of the tremendous growth of radio in the years after it was first introduced. Radio had a vitality that offered the kind of new interest and excitement that gets public attention. Television gives an even better service—one with far more popular appeal. Unquestionably television will make a great place for itself and I see no reason why, when the standards are set, television should not demonstrate as great and as romantic a story of growth as radio.

EUROPEAN television is assured of a rapid post-war growth, with England and Holland, or possibly Russia, leading the "picture," according to a last month report in *Radio Daily*.

Prior to the Nazi invasion, the Soviets were using RCA apparatus in their Moscow television outlet. Native equipment was being rapidly developed after three models. Experimentation had reached a point where a gigantic sight-and-sound studio was blueprinted for inclusion in the scheduled building of the Palace of the Soviets. The war halted all that. Defeat of the Axis will see a resurgence of activity, with emphasis on large-screen, community-type television. Equipment will probably be imported in the beginning with the view of creating a formidable Russian electronic structure.

STUART BALLANTINE, author, inventor, engineer and amateur, died May 7, at the age of 46.

Recently most famous for his invention of the throat microphone, which enables aviators and others to communicate with a minimum of trouble and in noisy surroundings, Ballantine has been well known to radiomen from the earliest days. He started his work as a radio operator with the Marconi Co., at the age of 15.



During the first World War he was in charge of the Radio Compass Laboratory at the Philadelphia Navy Yard. While there he invented a device for eliminating antenna effect. During his career he added more inventions, and held over 30 patents.

A writer of numerous papers on radio subjects, he was best known for his "Radio Telephony for Amateurs," which, issued in 1922, was for a number of years the only standard amateur handbook. Hams referred to it matter-of-factly as "the Bible."

Stuart Ballantine was a Fellow of the Institute of Radio Engineers, and was president of that body in 1935. He was also a Fellow of the American Physical Society and the Acoustical Society of America, and a member of the Franklin Institute, the Radio Club of America and the Harvard Club of Philadelphia. At the time of his death he was president of the Ballantine Laboratories of Boonton, New Jersey.

RADIO TUBES for civilian receivers actually shipped during the first three months of 1944 totalled more than 4,000,000, the Electronic Distributors Industry Advisory Committee was told last month by Radio and Radar Division officials of the WPB. Though this was slightly under scheduled civilian tube production for the quarter, it was indicated that second quarter shipments probably would be higher as a result of carryovers of tubes.

An official of the Office of Price Administration discussed with committee members a proposed new schedule of list prices for tubes for wholesalers and retailers, and a representative of the Office of Civilian Requirements discussed problems of distribution with the committee. Committee members were of the opinion that methods by which distributors have been allocating tubes to dealers have permitted all dealers to obtain their fair share.



Above, the diffraction pattern for tungsten; on opposite page, that for copper. Line spacing and brightness identifies the material.

X-RAY DIFFRACTION

REVEALS SECRETS OF ATOMIC STRUCTURE IN MANY MATERIALS

If the human eye were endowed with the power of super-microscopes, we would see a great many common substances as crystalline structures. Each atom in any one element possesses exactly the same elec-



The diffraction camera is extremely simple.

trical affinity for every other one. Consequently, the atoms arrange themselves in definite rows in 3-dimensional space. The atoms in copper, for instance, are arranged as in Fig. 1. This regular arrangement is called a spacial lattice, and the unit cell of Fig. 1 is repeated throughout the structure. The atoms at the top of the unit form the bottom of the cell above, and so on in all directions.

X-ray diffraction is the science that enables us to measure the spaces between the planes of atoms or groups, in such a unit cell, and from the information thus obtained

By FRED SHUNAMAN

identify the material, no matter how complex the lattice may be. This is because the extremely short wave lengths of the X-rays are of the same order as the spacings between the planes of atoms or particles in crystalline structures. These distances are extremely small, usually varying between 0.7 and 1000 Angstroms. (An Angstrom is 10^{-7} cm. one ten-millionth of a centimeter.) In diffraction X-ray work, target X-ray tubes giving the characteristic radiations of molybdenum, copper, cobalt iron and chromium are used. (See the article on X-ray tubes in the June *Radio-Craft*.) These give a wave length range between 0.709 and 2.28 Angstroms.

As shown in Fig. 2, these waves penetrate into the outer layers of the material being examined. Some are reflected from the top layer, others from the second, and so on. Rays reflected from a point on the material examined may be coming from different depths in the material. If these rays are allowed to fall on a fluorescent screen or a photographic negative, various figures, known as diffraction patterns, are obtained. For example, let us think of a point on the screen where the waves reflected from the second layer arrive exactly one-half wavelength later than those from the first layer. The crest of one wave then coincides with the trough of the next, and the two cancel each other. At some other point on the screen or film, the waves from the second or some other layer of the crystalline substance may arrive exactly one wave length behind those from the first. The result is that they reinforce each other and the impact on the sensitive surface is doubled. Thus dark and light areas are formed. Their distance apart is governed by the angle of the ray, the wave length of the

particular X-rays used and the spacings between the atomic planes in the material. Knowing the first two factors, finding the third is a simple matter. Some typical diffraction patterns are shown above.

By this indirect method we can learn something of the ultimate atomic structure of common substances. It is as if we were dealing with an invisible wire fence, patterns of which might vary. By placing our X-ray light so that the fence will reflect its rays, we can learn the pattern of the fence by studying the pattern these reflected rays make on a screen. As another example, we have probably all watched the wave patterns cast on a ceiling by a body of water outside the window of a building or the porthole of a ship. When the angle of the sun is right, an almost perfect reflection is cast. Now if we were to anchor a number of transparent electric light bulbs in the water, no difference would be made in the reflected image on the ceiling, as they would reflect roughly the same amount of light as the water itself. But if we produced waves on the water surface—by waiting for a wind or other means—the resultant wave patterns would show the presence of the hitherto invisible lamp bulbs, and by a careful study we could fix their positions simply by observing their effect on the waves sent among them.

For the purposes of X-ray analysis by the powder method, very small quantities of material are required; one-tenth of a milligram ($1/10,000$ gram) can be adequate for complete identification. The substance to be analyzed is placed inside a fine capillary tube about $3/10$ of a millimeter in diameter. This is mounted vertically at the center of a ring of X-ray-sensitive film held inside the metal body of the camera shown in the photo. A fine pencil of X-rays, about $1/2$ millimeter in diameter, is permitted to hit the specimen, which is rotated at low speed by a small motor. "Cones of

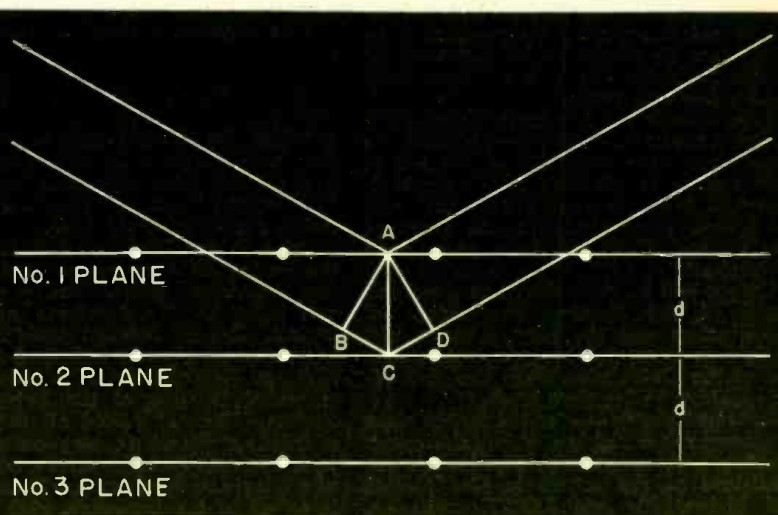
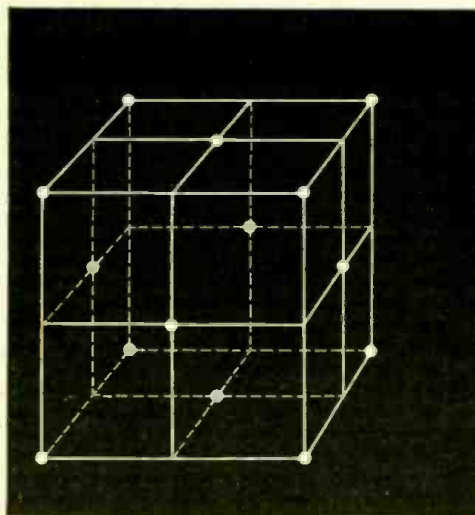

Fig. 1—Atomic structure of copper. Fig. 2—How X-rays reflected from different planes of a material make the patterns at top of page.



interference" are radiated from the specimen sections struck by the rays—these cones then strike the film in concentric lines around the central beam, as shown in Fig. 3.

The film is then developed and the angle between the diffracted cones and the main beam measured. The interatomic spacings of the specimen can readily be obtained from these measurements. This can usually be done by comparison with other published data, or by comparison with other films made from supposedly similar materials.

The simplicity of this method of analysis is not generally recognized. Diffraction patterns do not require careful measurement nor familiarity with application theories. Simple inspection is enough, provided a certain amount of experience has been acquired. A series of diagrams for a number of common materials is very useful for comparison purposes and as a guide.

Many cases occur in practice which are particularly suitable for the successful application of this method of analysis. One such problem is in the manufacture of phosphors such as are used in fluorescent lamps and cathode-ray tube screens. New compounds for these purposes have been discovered through the use of X-ray diffraction. Many phosphors fluoresce only when a small amount of impurity is incorporated during preparation. X-ray provides the first information as to the position of the activator (impurity) in the material.

Reactions in lead storage batteries have been traced by X-ray diffraction studies of material taken from the positive and negative places of the batteries when fully charged and in the completely discharged condition. From these studies information has been gathered that enables manufacturers to make better batteries.

In the manufacture of one type of thermionic cathode—such as is used in modern radio tubes—nickel wire is coated with barium and strontium oxide. X-ray diffraction showed that for maximum thermionic

A standard X-ray diffraction apparatus is to be seen in the photo at right. The X-ray tube is inside the shield at A, two cameras at B and the trackways upon which they run, at C. Fig. 3—below. The diffraction camera in action. X-rays emitted from the tube are "focussed" through the collimator and directed on the small sample in the tube at the camera's center. Reflected rays fall on the film and form the characteristic diffraction patterns.

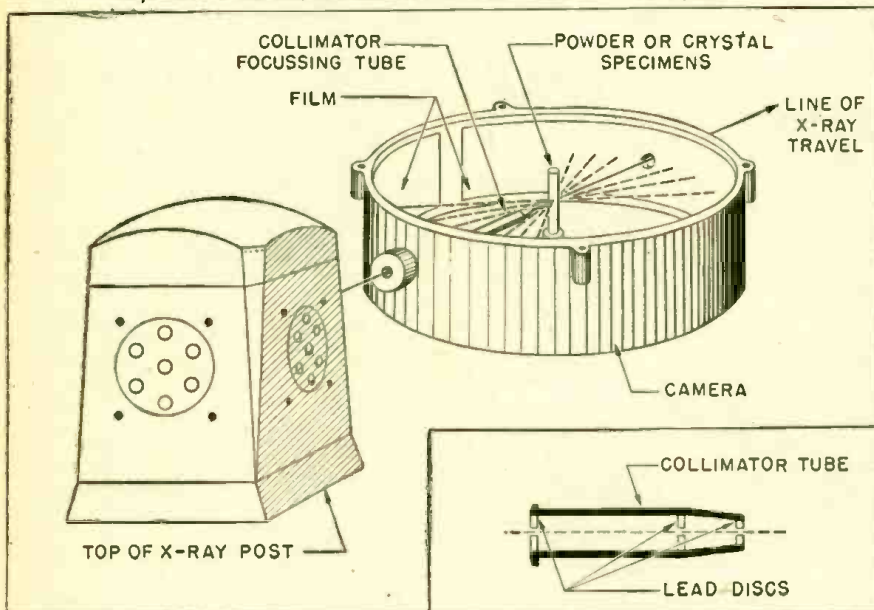

emission, the coating of the cathode before heat treatment should be in the form of mixed crystals of carbonates. In the manufacture of insulating materials used in the radio industry a very careful control of the raw materials is required. It was found by one manufacturer that clay from a mine in one part of the country produced satisfactory insulators, while a clay of identical chemical composition from another area was useless for high-frequency purposes. X-ray diffraction was able to show that this was due entirely to a difference in the particle size of the two clays used as raw materials. Thus it was possible to determine whether new clays would be suitable for the manufacture of this particular type of insulator.

It may be readily seen from these few examples that X-ray diffraction has a wide application. In the future, the importance of this precise tool will be more widely recognized and more commonly used. New developments in the field indicate that shortly X-ray diffraction will be used as an automatic means of controlling manufactured products, especially in many chemical process industries where the only changes in various important reactions are the result of rearrangement of atoms in the material.

Acknowledgment is made to the Technical and Publicity Departments of North American Philips, Inc., for the photographs and especially for assistance in preparing the manuscript.

X-RAY PROGRESS HAILED

Progress of the X-ray was hailed by Dr. William D. Coolidge, inventor of the hot-cathode X-ray tube, when he was recently presented with the Franklin Medal in recognition of his scientific contributions to the welfare of humanity.

One of the latest developments, said Dr. Coolidge, is the use of the X-ray as a thickness gauge under conditions where no other type of gauge could be expected to work.

White-hot sheet steel, at a temperature as high as 2000 degrees F, and moving at a speed of 20 miles an hour as it emerges from a rolling mill can have its thickness accurately measured with an X-ray outfit below and an ionization chamber or other X-ray intensity measuring device above the sheet. Through the measurement of X-ray transmission it becomes possible to have a constant indication of thickness and, if desired, to have the X-rays themselves control the mill so as to maintain automatically a constant thickness of the steel sheet.

Million-volt X-rays are today playing an important role in industry in the radiographic examination of various kinds of war material, including welds and steel casting, as thick as eight inches. Their main advantage over lower voltage rays consists in their greater penetrating power and the correspondingly shorter exposure time required. A radiograph through five inches of steel, made with a 400,000-volt outfit, requires three and a half hours, while with a million-volt outfit, only two minutes is needed.

From their original medical uses, the field of application of X-rays has been extended in many other directions, declared Dr. Coolidge, who cited, among others, the following:

"They may serve as a means of chemical analysis.

"They are used to measure the distances between the atoms in a crystal and so to determine crystalline structure.

"They reveal hidden flaws in structural materials.

"Through the measurement of the spacing of atoms they make it possible to show existing strains in structural materials."



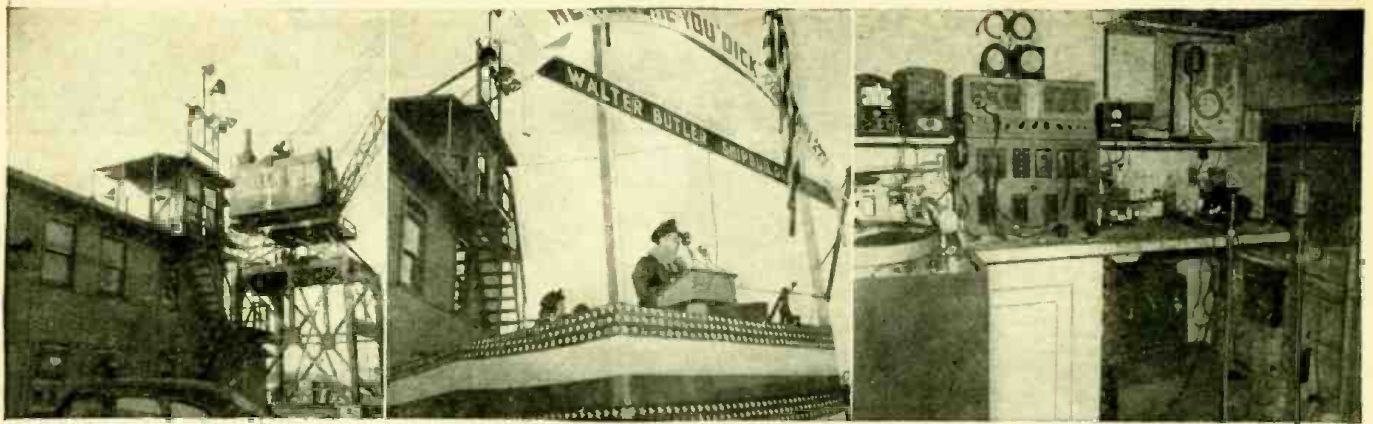

Battery of speakers over main sound room.

Major Richard Bong addresses the workers.

Some of the equipment in the sound room.

SHIPYARD USES SOUND

By T. J. RATHKE*

In a small watch tower atop the administration building of the Walter Butler Shipbuilders of Duluth and Superior, a complete sound broadcasting system has been installed and is now operating in the company's four separate yards which range from 200 feet to eight miles apart.

Serving over 9,000 employees, the sound system has been instrumental in maintaining a high degree of morale among the shipbuilders by the broadcast of daily news announcements, launching ceremonies, entertainment features and personal calls, all of

*Sound Engineer, Walter Butler Shipbuilders

which may be originated in any one of the four yards and piped to the other three.

The central control tower or sound room, located in yard 1, has a 50 watt RCA amplifier which feeds six speakers in that yard and six in adjacent yard number 2 from a 166 ohm line using separate matching transformers at each speaker. This same amplifier also feeds the two telephone lines of 500 ohms to yards 3 and 4, one-quarter and eight miles away respectively, where 50 watt booster amplifiers, using 6L6's operating in class AB2, are operated by remote control from the sound room in yard 1.

I use a V. U. meter on these lines to maintain them accurately at their required levels of 8 T.U.'s.

The A.C. switch is operated by a high-impedance relay which is energized by a 45 volt B battery. This relay controls a large low voltage relay that actuates a ratchet switch, turning on the amplifier every second time the relay is energized, and turning it off at every alternate operation. The same set of wires used here are used to feed the input transformer of the amplifier. To keep the 45 volts of D.C. out of the primary winding of the input transformer, .1 Mfd. blocking condensers are used. On the other end this was done by the use of a D.P.D.T. switch with a three-inch handle attached to a spring which keeps it in an off position. In this way the relays are given only a momentary shot of 45 volts, at the same time disconnecting the output transformer feeding the 500 ohm lines.

We also have two 30 watt amplifiers, an Operadio and a Deluxe Airline built by Hallicrafters, to use at launchings and yard ceremonies where P.A. equipment is needed.

A large RCA recorder with a 16-inch turntable, recording at 78 and 33 $\frac{1}{3}$ RPM, has enabled us to record our day-time talent shows, band concerts and other programs which we play back to the night shift. Launching ceremonies are recorded for later broadcasts over local radio stations, and occasionally special news bulletins have been taken off the air and put on our sound system at lunch time. A 30-minute recording program with selections from our library of 600 records is played to the men while they clock in and out between shifts.

In order to broadcast our noon-time programs in our low-ceiling, 174-foot cafeteria, I constructed a special baffle with a square box in the center housing a 12" P.M. 15 watt speaker with a horn attached to both ends, flared out to the sides and flat on the top and bottom. With this baffle the sound is projected to both ends of the long cafeteria from the center with an almost uniform volume level.

Recently a small portable sound room that can be easily handled by a crane, and complete with a recorder, amplifiers, speakers and mikes mounted on rubber shock absorbers, has been added to our equipment. This unit, connected to our main sound room with portable rubber cords, has greatly facilitated the handling of launching programs.

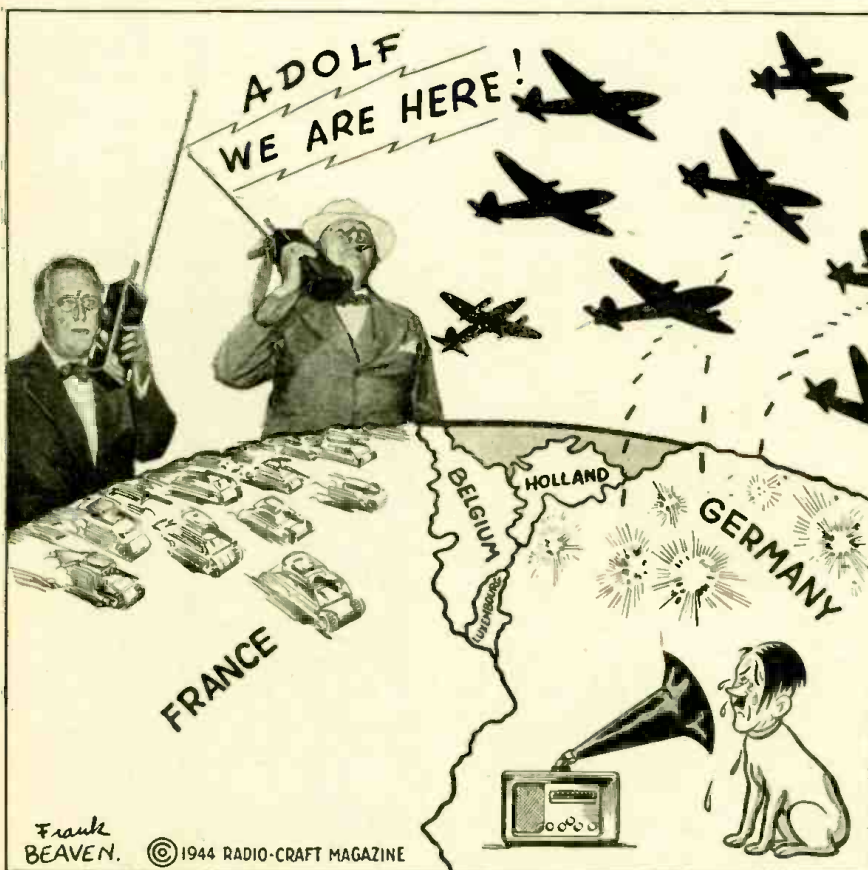

Frank Beaven. © 1944 RADIO-CRAFT MAGAZINE

"HIS MASTERS' VOICE"

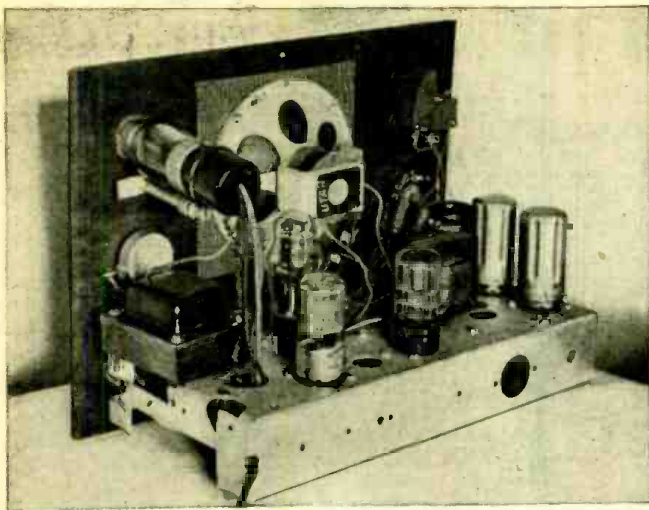

At the right we see the completed signal tracer, with the various controls marked. Above is a back-panel view of the same instrument.

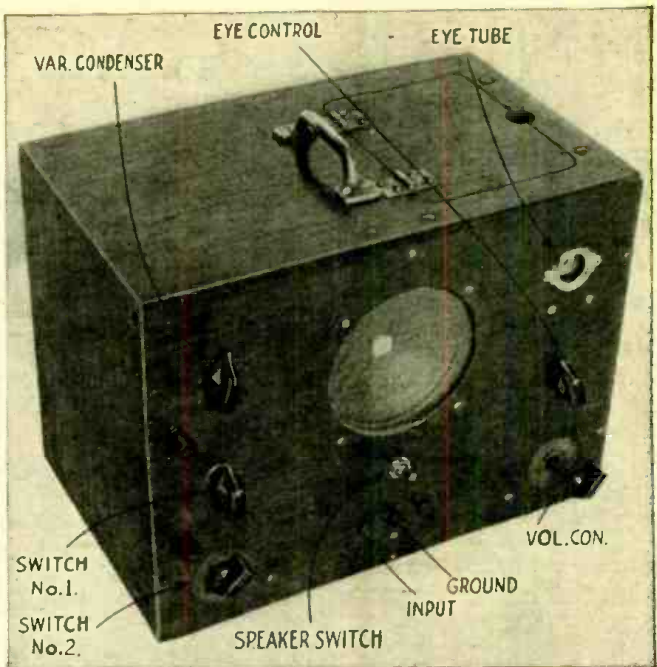

Signal Tracer

From a Worn-Out Receiver

By JOHN F. COOLEN

ALTHOUGH Signal Tracers have been on the market for some time, they still do not enjoy the popularity they deserve among servicemen. This is probably due to the high cost of the manufactured instrument, the difficulty of getting special coils for the various ranges—if home made—and many other factors familiar to the serviceman. This Signal Tracer was designed with the above difficulties in mind and will do all that the average radioman requires.

wire to form a small capacity, and anchored in place with coil cement. Next a piece of spaghetti is placed over this assembly to hold it in place. This small coupling condenser is then placed in the fibre tubing of the probe, the hook-up wire is stripped back and locked in place with the nut at the end of the test probe. At the other end of the R.F. and I.F. lead the shielding is cut back and the center wire fastened to an insulated phone tip. A short wire is then fastened

from the shielding to another phone tip and this is plugged into the ground terminal on the front of the panel. The basic principle of this probe is that twisting two insulated wires together forms a small capacity. The A.F. probe is simply a test lead and need not be shielded. I also use mine as an antenna when tuning in a station. The ground lead is the same as the A.F. except that a small battery clip replaces the test probe.

To use a Signal Tracer the serviceman should know the operations of the various tubes in a set and their base connections. (Continued on page 637)

CONSTRUCTION DETAILS

Most of the parts were obtained from the junk box and a small receiver. The chassis was made to fit a cabinet which previously held an old battery set. As the power transformer was already on the chassis it was left in place and the various sockets, output transformer and other parts arranged for shortest leads. As much wiring as possible should be done before putting the front panel—which contains the speaker and most of the controls—in place.

The panel is drilled for the speaker and the various controls, and then bolted to the chassis with three bolts. It was necessary to use a piece of 1/2 inch plywood for the panel, as metal was unobtainable. However, little body capacity can be noticed.

The antenna lead and the leads to the grid of the first R.F. tube should be shielded if possible. It is also good practice to place a piece of shielding behind the tuning condenser and ground it to eliminate any hand capacity when tuning in a station. Wiring should be done slowly and carefully and none of the by-pass condensers should be omitted. Make your leads as short as possible between tubes to obtain best results. The wires from the selector switch should be separated from each other or shielded.

THE TEST PROBES

The R.F. and I.F. lead is made from 3 feet of shielded wire and the test probe is constructed as follows: about 1 1/2 inches of shielding is cut back and the rubber covering is stripped from the center wire for a distance of 1 inch. A piece of insulated hook-up wire is wound around this center

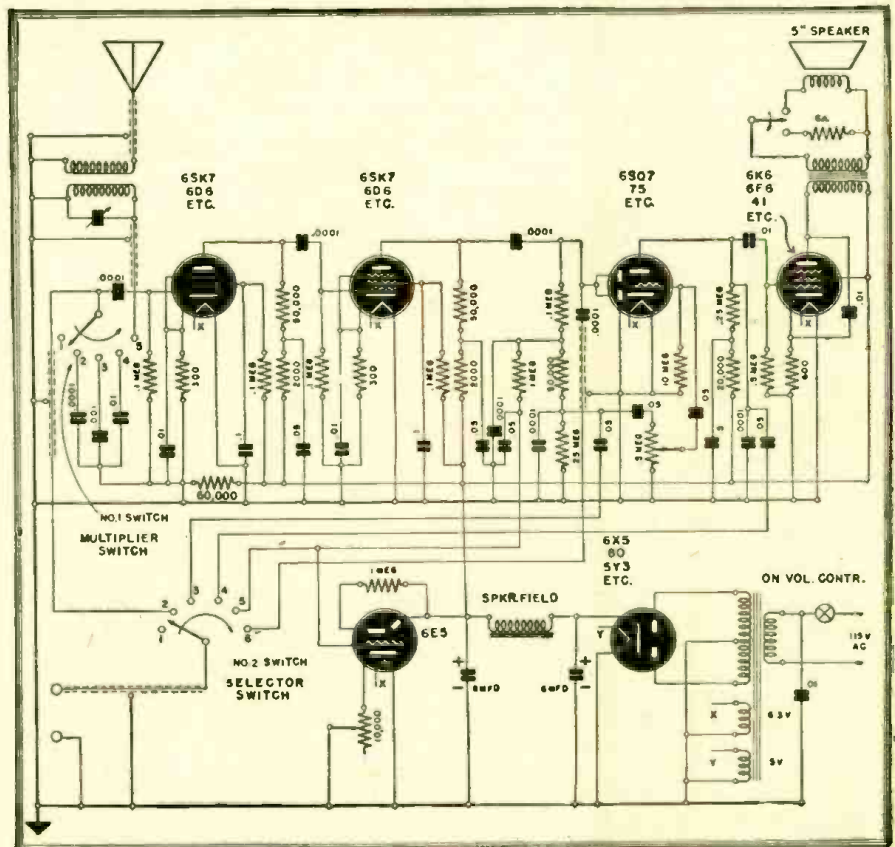

Complete schematic of the signal tracer. The plan is adaptable to any available receiver.

INDUSTRIAL ELECTRONICS

PART V—BIOLOGICAL AND THERAPEUTIC APPLICATIONS

YOUNG men seeking careers in electronics should not fail to investigate one of the most promising and yet one of the least recognized of the new arts. It is quite true that electronics will

By **RAYMOND FRANCIS YATES**

be widely used in machine control, in photography, railroading and communications.

Its greatest service for the human good may come from the many electro-biological experiments now being performed and anticipated. This writer predicts that twenty years from now by far the largest part of the treatments given during hospitalization will be electronic in nature.

A beginning has already been made, but it is a beginning only. We have our radio-thermic fever machines, short-wave diathermy, electrocardiographs and the like. These amount only to modest beginnings. The big things are yet to come. The electronic microvoltmeter and the electron microscope are

the most promising things that appear on the horizon of the future. One cannot begin to estimate the amount and degree of human suffering that may be eliminated because of these and other types of electronic instruments.

Most of the many electrobiological experiments now being conducted are based directly on the detection and measurement of low currents and voltages through the agency of electron-tube circuits. Years ago, it was known that many of the body functions generated electric currents of extremely small volume but no reliable means were available for their measurement. The VT instruments have not only measured these biological sources of potential but have also caught many parts of the body in the act of creating electricity. Indeed there is little that either man, animal, insect or fish can do that does not create an attending electrical pattern. The movement of a muscle, the response of a nerve, the beating of the heart, ovulation, indeed even "thinking a thought" creates a definite and, in some measure at least, readable current.

Although the many electronic current and voltmeters used in biological investigation vary a great deal, one of the simpler circuits used for the determination of voltage is illustrated in Fig. 1. (This meter was described in the May *Radio-Craft*.) It is now part of the rather famous equipment developed by H. S. Burr, C. T. Lane and L. F. Nims of Yale University for the detection of ovulation in human females. Those familiar with the Wheatstone bridge will notice that a bridge type circuit is employed. This electronic instrument serves as the one best means so far devised for the measurement of potentials between living tissues.

Those familiar with biology know that the neuron is a specialized cell for conducting nerve impulses. Not so generally known is the fact that the nerve impulse itself which is passed along from neuron to neuron produces thermal and chemical manifestations as well as electric current. There is also the axon, a parallel nerve fiber. Investigation shows that the axon and neuron conductors bear definite resemblance to ordinary electrical conductors although, as previously stated, thermal as well as chemical manifestations take place.

Figs. 2 and 3 illustrate the electrical model of the axon and the nerve fibre cross section. The latter will be found to possess the ordinary attributes of all electric circuits, i.e., resistance, capacitance and inductance.

Recent biological investigation aided by electronics, shows that at least five different sources of electric current generation are in the human body. For one, there is the semi-rhythmic wave forms produced by muscles. Eating a piece of cake or batting a baseball has a definite electrical pattern that may be traced and recorded by the aid of an amplifier of the proper design used with an oscillograph. Current is also generated by nerve fibers. Such currents are called "action potentials" by those working in this interesting field.

There is also D.C. difference in potential in all living tissue. For instance, the outside of a living cell has a potential different than the interior. Although those potentials

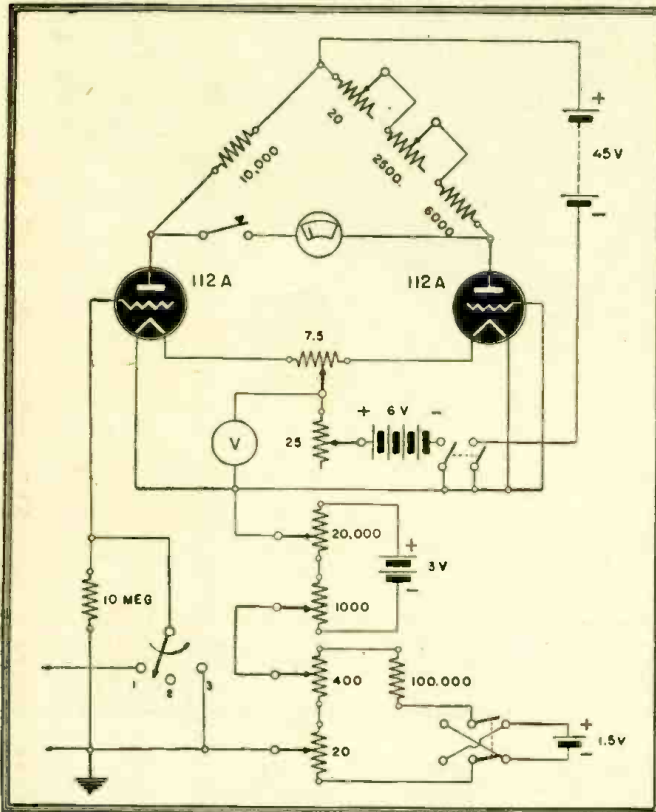
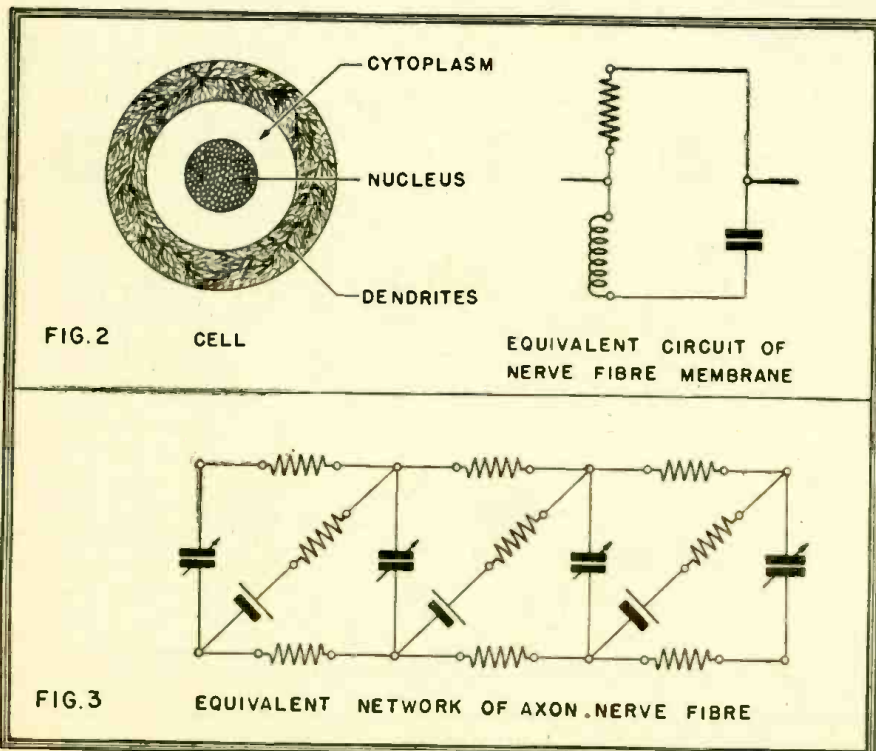

Fig. 1—A 2-tube biological microvoltmeter. Figs. 2 and 3—Physical cross-section of a nerve compared with its electrical diagram.



are extremely small and were immeasurable before the advent of the electronic voltmeter, they may now be detected and measured with a fair degree of accuracy.

Perhaps one of the most amazing currents in the animal system is that which carries sounds to the brain from the ear. Here, as might be surmised, is a modulated, microphonic current and the ear mechanism itself apparently functions as a very delicate and very sensitive microphone.

The electrical wave forms generated in the human brain itself are still more interesting. There appears to be growing evidence that thinking is an essentially electrical process. More than this, special FM carrier amplifiers, differentiating circuits and trigger circuits giving constant amplitude pulses for time axis recording of 20 variables today offers the most promising approach to brain injuries and their quick, accurate diagnosis. Indicating instruments or pickups of the capacitance type are used on individuals under examination. Such capacitance indicators when employed with the proper circuits are able to record respiration, tremors in finger tips and pulse. A microphone is used for speed and direct skin contacts are employed for the recording of movements of the eye and facial muscles.

The circuits employed for this work are extremely complicated and involve much special apparatus. Some idea of the system used, however, will be gained by an examination of Fig. 4.

Many of the electronic devices now being applied to biological investigation are extremely clever. Take as examples the measurement of blood flow and contractions of the stomach. The patient swallows a small rubber balloon which is connected with a U-tube mercury manometer. Thus contraction in the stomach will squeeze the inflated balloon and affect the column of mercury in the manometer. A beam of light controlled by the moving mercury column will permit the stomach to write its story on a moving tape through the agency of a VT amplifier. A double-walled section of the balloon also carries a sensitive thermo-couple, the lead wires coming up through the center of the small rubber tube and to a special D.C. electronic amplifier. Thus can the increase or decrease in the flow of blood be watched by increases and decreases in temperature.

Then there is the encephalophone. This is an instrument used to convert brain potentials as low as 10 microvolts into audible sounds. (See "The Encephalophone," *Radio-Craft*, April, 1943.) The frequency modulation circuit used with the encephalophone is shown in Fig. 4. The electrodes applied to the patient are merely small concave lead buttons filled with a conducting jelly and placed concave side next to the scalp. Adhesive tape is used to hold the scalp electrodes in place. A large number of such connections are made and carried to a selector switch so that the investigator may shift his attention to different parts of the head of the patient under observation. The device is used in a screened cage to shield off all stray 60-cycle wave forms.

It has already been observed that the form and frequency of brain waves depends entirely upon the function stimulating the current. In a small measure, it is possible to determine the effects of certain emotions as they relate to the magnitude and frequency of potentials arising in different parts of the brain. The approach of an epileptic fit can be detected if persons subject to such upsets are under observation at the time.

We cannot hope to present even a small percentage of the many highly specialized

circuits now being employed in biological investigations. They are far too numerous and become more so as the field of research opens wider and wider. However, one of the simpler and more commonly employed psychogalvanometric circuits is illustrated in Fig. 5. This is extremely sensitive and may be easily set up by any clever radio repairman.

Aside from the widely used radio therapy devices wherein deep-seated heat is produced in the body by induced high-frequency current, the most widely employed electronic device in the biological field is the shock therapy mechanism. For some time now it has been known that drugs like insulin or, better yet, metrolol, produce a form of mental shock that is extremely beneficial in the treatment of certain nervous and mental disorders. Unfortunately the use of metrolol often created conditions that made the cure worse than the disorder itself.

An Italian experimenter found that an electronically created and applied shock was equally as effective and simple, and had the added advantage of having no bad after-effects. The shock of 90 volts A.C. was applied directly to the temples of the patient for a period of .01 to .05 second. Invariably the result was sudden prostration or total unconsciousness. The patient finally awakes with amnesia insofar as the treatment itself is concerned. There is no pain, no fear to have more treatments. Sometimes no more than three or four are needed, sometimes as many as thirty treatments are necessary.

And, of course, there is the so-called radio knife which has long been used in surgery but which may be unfamiliar to newcomers in the study of electronics. This special scalpel is connected to a R.F. generator which supplies it with R.F. current

(Continued on page 624)

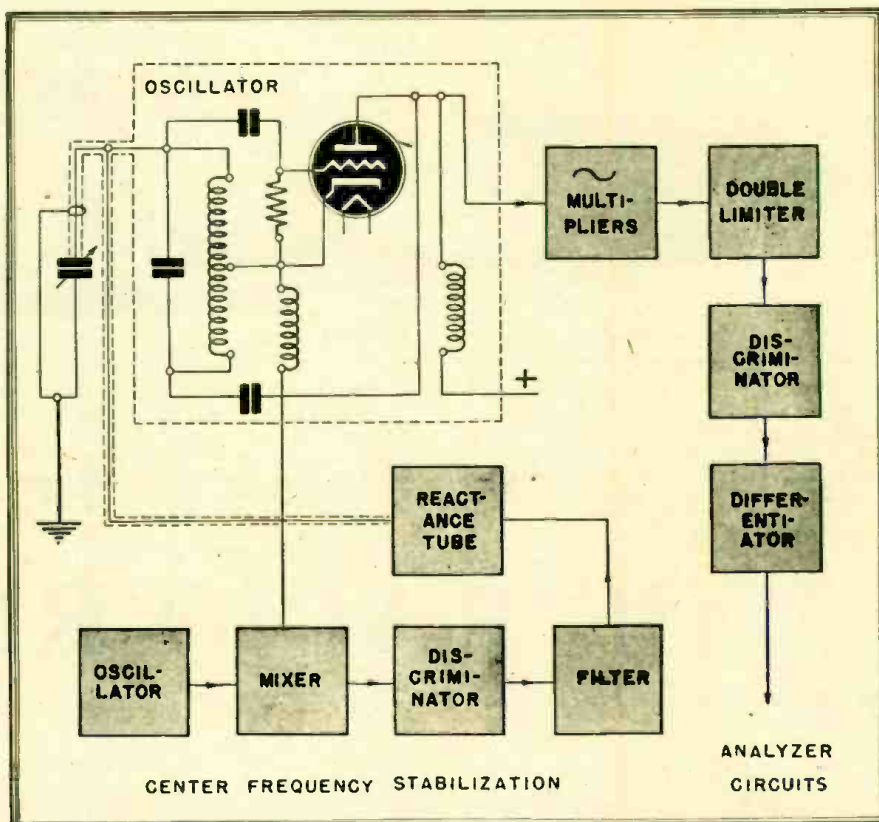

Fig. 4—Block diagram of apparatus used in observing currents generated in the brain.

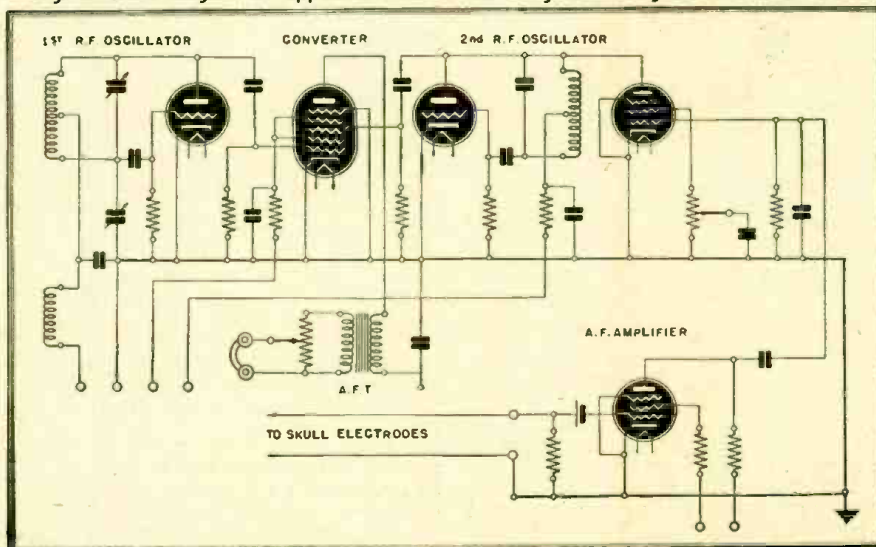
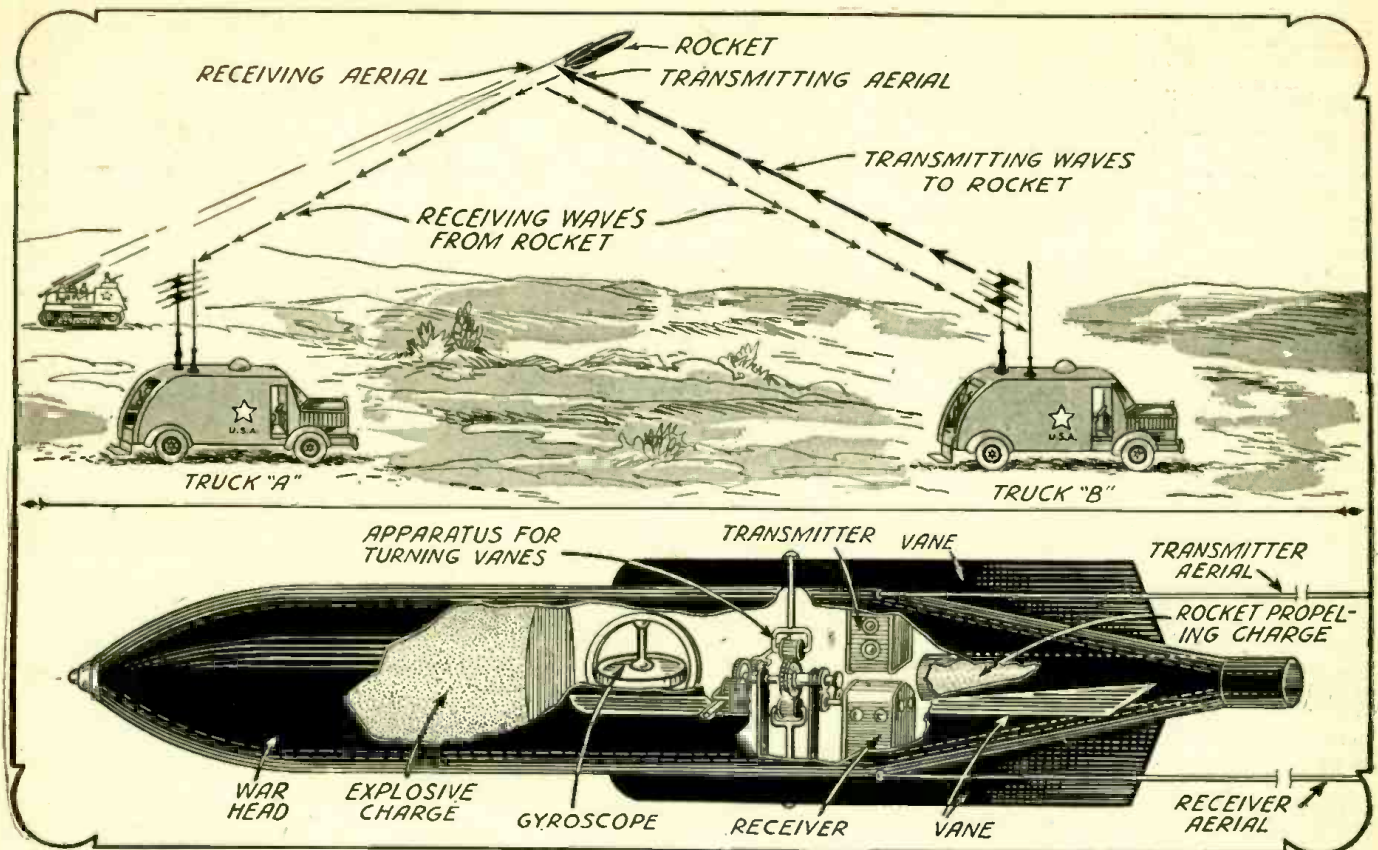

Fig. 5—A simple type of encephalophone, a device for listening to the brain waves.



How signals are sent to and from the Radio Rocket is shown in the top illustration. By means of automatic triangulation between truck A and truck B, the position of the rocket in space is always known. The radio waves from truck B automatically correct the flight of rocket when this becomes necessary. Lower panel shows an idealized view of rocket. Note that the radio apparatus, as well as the gyroscope, occupy only a fraction of the space shown here. The pictured apparatus has been expanded out of proportion to the whole. Thus, the rocket propelling charge in an actual rocket would be many times larger than shown. Note that the radio remote control operates the horizontal as well as the vertical vanes on the rocket, making it possible to steer it over its correct course from a distance.

COVER FEATURE:

THE RADIO ROCKET

By HUGO GERNSBACK

ROCKETS, which have become very popular with all of the warring armies during this war, are still in their infancy as far as technical perfection is concerned.

To be sure, rockets are perhaps one of the most ancient artillery devices, they having been used as early as 1232 A.D. by the Chinese. In this war, they have been used increasingly as an anti-aircraft weapon in order to bring down enemy planes. They have also been used for specific offensive purposes where the target is large, as for instance, a city or a village which is to be bombarded.

The great attraction of rockets for the various armed forces lies in the simplicity of launching the rocket. No huge gun is necessary. It can be shot off by means of a simple, light, launching device. For this reason, the present-day big and usually heavy guns can be dispensed with in the shelling and quick pursuit of the enemy. The rocket thus has a considerable advantage over the standard unwieldy cannon.

The main difficulty with rockets, however, is their inherent inaccuracy. When a regulation shell is fired from a cannon, the shell weighs exactly the same amount at the moment of its firing as when it strikes the target. For this reason, its flight is tolerably accurate. It is mainly influenced by the earth's gravitation and wind drift.

Not so with the rocket. The rocket propels itself. It therefore is its own gun, so

to speak. It carries its own propulsion charge and therefore weighs considerably more when it starts on its flight than when it hits the target. It is subject to the earth's gravitational pull as well as cross winds, the same as a cannon-fired shell, but inasmuch as the rocket changes its weight continuously, getting lighter progressively on its flight, it is most difficult to calculate exactly where it will strike, due to its constant loss of weight on the one hand and cross winds on the other.

A third factor also enters the picture, because as the rocket becomes lighter, it tends to "oscillate" or "wobble" and does not fly a perfect course. Therefore rockets cannot be trusted to hit a small target at present. This is particularly true if the flight extends over a number of miles.

It is quite conceivable that these objections will be overcome by purely mechanical means in the not too distant future. Indeed, it is possible that rockets can be built some day that will strike their targets with fair accuracy.

When it comes, however, to long-distance rockets—those that travel at a distance of 50 to 100 miles and over—the problem becomes very much more complicated and it is doubtful that it can be solved by purely mechanical means in a foreseeable time.

We have, however, an ideal means of

controlling the flight of a long distance rocket—namely, radio remote control. It is quite certain that this means will be used very soon because it holds great attraction for those who believe in the rocket as well as in its future.

The idea of the Radio-Controlled Rocket is by no means new, and its proposal has been made by various technicians many times.

The Germans, for instance, over Anzio Beachhead and at other points, have used a radio-controlled glider bomb on which we have reported several times.*

To be sure, the radio-controlled glider bomb was not a true rocket because it was launched from a mother airplane and used glider wings. The bomb was dropped from a height of 25,000 feet and guided to the final target; but the point is that it was actually controlled by radio to insure better accuracy in hitting its target.

On our cover and in the accompanying illustrations is shown the future Radio Rocket and how it will most likely be operated. The cover illustration shows the mobile rocket launching device. The mobility is necessitated by the fact that the enemy, observing the rocket flash discharge, quickly obtains its position and will shell

*See RADIO-CRAFT, November, 1943, issue, "Radio Glider Bomb"; also further description of the actual device, in RADIO-CRAFT, May, 1944, issue.

(Continued on page 625)

Practical Electronics

PART IV—ELECTRONIC FLOW IN GAS AND VACUUM

By FRED SHUNAMAN

ELECTRONIC devices differ sharply from ordinary electrical machinery in one respect. Somewhere in every piece of electronic apparatus there is a flow of electrical current *without conductors*. This type of conduction was intentionally omitted from the last lesson, for it is so important as to deserve a whole section by itself.

Conduction without conductors sounds startling at first. Yet we are all familiar with it, even outside ordinary electron tubes. Who has not seen a stroke of lightning? The spark between the points of a spark plug—or between your finger and a radiator in a dry carpeted room—is also a flow of electricity without a conductor. It is fairly well known—and can be proved experimentally by breaking one—that there is no conductor between the ends of a fluorescent electric lamp. Yet current flows, as a monthly checkup on the electric meter shows.

CONDUCTION IN AIR

There are two kinds of electron flow without conductors—flow in gases and flow in a vacuum. When lightning strikes, we have a flow of current in the gases which compose our atmosphere. Air is normally a fairly good insulator, but when subjected to an extremely high voltage, "breaks down," and carries current in a special way.

If two points with a very large voltage difference between them are brought close

together, they will flash across and form an arc. The set-up of Fig. 1-a is commonly used to demonstrate this. The points are attached to some such source of extremely high direct current as a Wimhurst machine, which can produce voltages up into the millions. As the voltage is gradually raised, the electrons on those atoms which are nearest the positive point are attracted with tremendous force toward it. The electrons nearest the negative point are repelled with equal force.

These forces are passed from atom to atom, with the result that all the atoms in the space between the points are pulled somewhat out of shape, with their electrons all drawn toward the positive point. There is no tendency for the atoms themselves to drift in either direction since the positive nucleus of each atom is attracted to the negative point with the same force that its electrons are drawn to the positive; or if you prefer to put the story in terms of repulsion, the nuclei are repelled from the positive point with the same force that the electrons are repelled from the negative one.

THE ELECTRIC ARC

We know from experience in mechanics and everyday life that if you make the strain high enough, something is bound to give way. So it is in electronics. If the voltage is raised high enough, a few of the electrons nearest the positive point will leave their atoms and jump over to it.



One of the smallest industrial rectifiers. Some larger ones are several feet in diameter.

Electrons are ejected into the air from the negative point. This can be checked by the experiment of Fig. 1-b. The match-flame is blown to one side by the "wind" which consists of numerous electrons.

As the number of electrons on the move increases, some of the bereaved atoms start to move, impelled by the repulsion of the nearby positive point and the general negative attraction in the other direction. Then the fun begins! An ion is nearly 2,000 times as massive as an electron, and moves slower, but with vastly greater effect. It does not get far before it picks up an electron, and by all the laws of electronics, should settle down. This is exactly what does *not* happen. During the shake-up the chances are

(Continued on page 626)

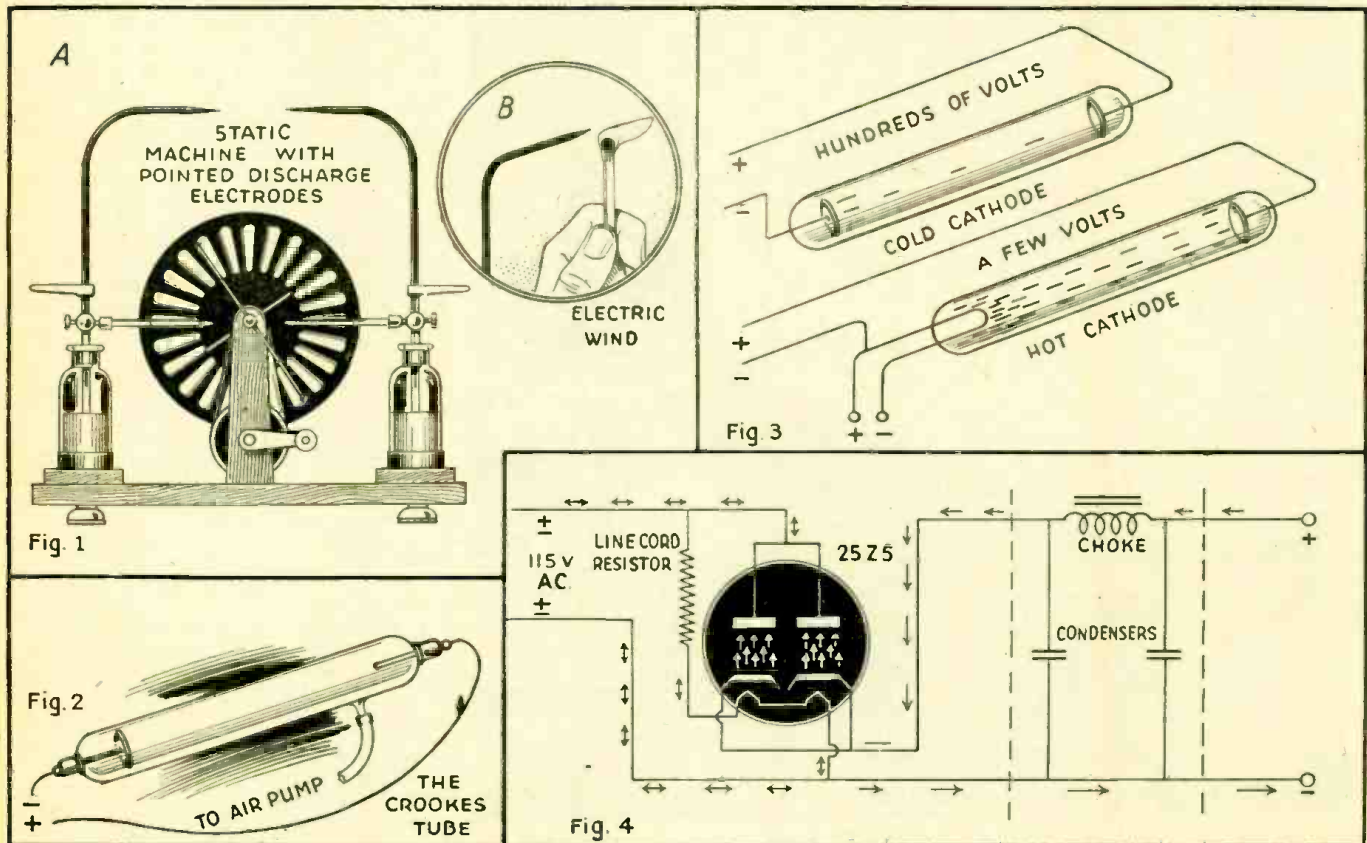

Better Television Coming?

Wide Band System Will Produce Greater Definition

By A. PASCALE

WHAT will the post-war world have in store for us as far as television is concerned? During the past month numerous discussions, initiated by the Columbia Broadcasting System's proposal for a high-definition post-war television system, have taken place. If CBS's plans are put into effect, there is no doubt that the image on the future television set will have more "eye-appeal" than at present.

The majority of individuals who have seen a telecast have felt the need for more definition in the image. They have had to squint and strain their eyes to see some object in the background or read some lettering—often to no avail. The layman in the audience does not grasp the reason for this condition; but nevertheless his interest in television is reduced. It is a known fact that people who bought television receivers made more use of them when they were new than after several months had elapsed. The reason for this is apparent. During the first few weeks or months, the television receiver was a novelty; but after this period had passed, sufficient enjoyment was not derived from the use of the set, therefore the interest waned. If this condition is allowed to continue, television will never be successful.

COARSE-SCREEN IMAGES

The present system of transmitting television pictures on a band width of 6 megacycles, mostly below the 200 megacycle section of the spectrum, results in the produc-

tion of coarse-screen images. By comparing Fig. 1-a, which shows as closely as printed plates make possible how a television image appears today, with Fig. 1-b, which represents the proposed post-war television image, it is obvious which is the more satisfactory of the two. Fig. 1-a contains fewer



dots per square inch, therefore detail is lost. (For printing purposes halftone dots had to be used in their correct proportions instead of horizontal television "lines.")

Paul W. Kesten, executive vice-president of the Columbia Broadcasting System, recently stated that the production of television pictures within a 6-megacycle band is comparable to playing a tune on a three-octave piano. Any tune can be played on a three-octave piano, but within a limited

range. The same holds true of television on the 6-megacycle width—any picture can be reproduced, but within a limited range of definition.

FINE-SCREEN IMAGES

The only way more detail can be added to a television picture is to increase the number of lines in the image. The image on the screen of a television receiver of

today contains 250,000 tiny picture elements which the eye blends into one image. If a band-width of 16 megacycles were used for television transmission there would be 585,000 picture elements; thus giving a clearer image and bringing out more details than heretofore. By having a fine screen (more elements per square inch) texture of material will be more apparent. Imagine a picture of a charming young lady in a taffeta evening gown. How dull the whole scene would appear if the texture of the gown is not visible! A picture showing the folds of the garment with all its accompanying shadows and highlights would add glamor to the entire scene.

This is exactly what is to be anticipated in the proposed post-war television. If an advertisement is flashed on the screen in post-war television, the lettering will be visible and readable; and if an enthusiastic baseball fan enjoys seeing a game telecast, he will be able to see the far end of the field, pick out his favorite player and follow his movements. Such detail is a "must" for successful television and will come within the realms of reality once television is moved into the ultra-high-frequencies and broadcast on the proposed wide band. It must be remembered that the finer the screen, the more can be brought into fine-detail focus by the television camera, whereas the coarser the screen the more detail is lost—making the difference between "good" and only "fair" television images.

ENLARGING IMAGES

The proposed system is more suitable for enlargement than the present one. Compare Figs. 2 and 3. Fig. 2 shows a small part of a pre-war television picture as it would appear if an entire 10-inch, 250,000 element image were enlarged to eighteen inches. Fig. 3 shows the same picture reproduced with 585,000 elements. For the purpose of illustration these pictures are also reproduced in the half-tone method, as television "lines" are not adaptable for printing purposes. When an image is enlarged, no more picture elements per square inch are obtained—the elements are simply spread farther apart. It can easily be seen that the post-war television image is more suitable for enlargement than the pre-war



Fig. 1-a (left) A present-day television image. Fig. 1-b (right) represents the proposed television image which will be produced on a wider band than being used today.



Fig. 2 (at left) is an enlargement of a small portion of a present-day television image. Note the amount of space between the halftone dots.



Fig. 3 (at right) is an enlargement of the same portion of a picture in post-war television. Note the clearer definition.

image, because it will not "disintegrate." By this we mean that the lines will not be so far apart as to make the picture coarse.

COLOR TELEVISION

The use of the same wide band also makes possible a good television image in full color. Although full color images were possible in pre-war television, the same coarseness in screen existed as in black and white television. The proposed post-war color image will contain more than three times as many picture elements as the pre-war black and white image. Nine hundred thousand tiny units are blended into each "color frame." Compared with the post-war black and white television each color picture contains 50% more picture elements.

U.H.F. FOR TELEVISION?

Before a thought is given to improving television by allocating the ultra-high-frequencies—above 200 megacycles—for the use of television many pros and cons have to be thoroughly gone over and understood by all concerned.

First there is the problem facing the Federal Communications Commission. It is the responsibility of the FCC to allocate proper bands for the various uses and to divide the radio spectrum efficiently.

A writer of an editorial appearing in *The New York Times* deemed the question of "ghosts" as very important. He pointed out that in the higher frequencies the waves of radio resemble those of light, thus causing reflections that create disturbing "ghosts" on the screen. Though this is technically correct, we are confident that the "ghosts" can be frightened away without too much research work. Thus we need not fear them and can eliminate them from our discussion.

Another angle must also be considered. As yet this improved television is not an engineering certainty. CBS claims "it is at the very fingertips of engineers, but not yet in the palm of their hand." Should the FCC allocate the channels on the strength of these possibilities? It may also be imperative that television occupy both ultra-high-frequencies and its present frequencies for a short period, as it would be impractical to build sets which are capable of receiving both high and low frequencies. The old sets cannot be scrapped suddenly. Therefore, it may be necessary to reach

both the owners of the new and old sets simultaneously for a while. Will this move be wise?

James L. Fly, chairman of the Federal Communications Commission, announced his opposition to any move to freeze television standards at their present level. In supporting the policy for improving television he declared that it would be harmful "to close the door at this point" on the creation of the immediate post-war video standards if "injury" to the majority of persons is to be avoided. He described as "silly" some of the arguments advanced against changing the present policy.

E. K. Jett, a member of the FCC, suggested that immediately after the war there might be two television bands. There would be transmission under the old and new standards, until television on the ultra-high-frequencies was firmly established and sufficient new sets built.

Allen B. DuMont, president of the Allen B. DuMont Laboratories and of Television Broadcasters' Association, is not in agreement with the proposal to move television into the upper section of the spectrum. He declares that the present standard for television pictures is known to be practical, whereas the other has not as yet been proved from the engineering standpoint.

The Radio Technical Planning Board, whose members represent most of the country's privately employed engineers, has so far maintained silence on the subject.

The manufacturers of television equipment have a special interest in the proposals. An improvement in the quality of television pictures will greatly accelerate business for them. But there is one serious angle to be considered. Those manufacturers who can be called television pioneers have invested millions of dollars in television, when it was still in its infancy. From 1939 until our entrance into the war, they sold many commercial transmitters and receivers. Then war was declared and they went 100% into war work. Not to resume television manufacture immediately after the war would impose great hardship on these television pioneers. It would mean that after the war they would get no returns on their large investments. Not only income, but time as well, would be lost while new transmitters and sets would have to be engineered and tested.

Other problems face both the broadcaster and the public. Broadcasters do not sell, but they are potential buyers of trans-

mitters, studio and mobile equipment. They will have to face a period of many years of cumulative deficit. Television programs must be produced and broadcast long before there are sufficient homes equipped with television sets to provide a profitable audience. In our present-day system advertisers are not able to show their product to great advantage due to lack of definition. In the proposed system the opportunities for effective advertising will be greatly increased. The sooner the television image is improved, the sooner will the public desire to buy television receivers and the sooner will the broadcasters' problem be reduced. Broadcasting can be profitable only when there is a large audience.

As far as the general public is concerned the investment in television sets to date has reached two million dollars. Comparatively speaking this is not a great sum. However, when the manufacture of sets will be resumed, the public will again be in the market for television sets. Will these sets be built to receive high or low frequencies? If they are built to receive low frequencies, what will the result be when television is moved into the ultra-high-frequencies? These sets will invariably become obsolete and only be good for the scrap pile.

If, after the war, time is wasted in discussion on the subject of improving television, the public will continue to purchase television receivers of the old type. The investment—both in receivers and transmitters—will continue to grow by leaps and bounds.

Every additional television set of the old type sold will be one more obstacle in the path of improved television, and faced—some years after the war—with the prospect of scrapping \$8,000,000 to \$10,000,000 worth of receivers and their complete broadcasting set-up, both manufacturers and broadcasters will be forced to be conservative and oppose the inevitable improvement as long as possible. Thus it is conceivable that television might be a failure even before it will have had a chance to be fully developed, and when the change is made, losses both financial and psychological will be far greater than if the step were to be made at the present time, when receivers are few and already some years old, and the television broadcasting system still in the embryo.

Television is on its forward march. Everything must be done to help it!

POWER FOR PORTABLES

Technique of making 3-way sets from battery receivers

By R. S. HAVENHILL

THERE are a large number of miniature battery personal portable radios which are now on the "shelf" for lack of "A" and "B" batteries. The owners of these sets will be grateful for AC power packs to put them back into operation. However, they would much prefer to have them converted into 3-way portables which will operate not only on batteries but on 115 volt A.C. and D.C. power lines. There is little or no information in radio periodicals concerning the problems encountered in the conversion of these sets. The serviceman does not like to repair them, let alone make any uncertain changes in circuits for three-way operation, without advance knowledge on the outcome of such changes. While separate power packs for AC operation of these sets have been described in past issues of *Radio-Craft*, it is the purpose of this article to give the writer's experience regarding the conversion of one of these portables to a 3-way portable in which all parts are completely self contained in the radio itself. The conversion herein described was on a Crosley 45-BV commuter miniature portable (see photograph) but the design with modifications is applicable to other personal portables. Any serviceman or radio experimenter with a moderate amount of patience, ingenuity and who is handy with tools, especially a small pair of tweezers and a pencil type soldering iron, can do the job.

Briefly, the job consists of connecting the tube filaments in series (with proper shunts), replacing the 1.5 volt "A" battery

with pen-light cells connected in series to furnish the higher "A" voltage and the construction of a small built-in one tube 45Z3 power pack to furnish both the "A" and "B" current. With this system no complicated wiring or switches (which cannot be made in the shop) to switch from series to parallel filament operation is required, as the filaments are in series at all times for both battery and AC operation. During AC operation the batteries float across the power lines and act as filters. When operation is on batteries the power supply voltage divider system is disconnected at the rectifier cathode by removal of the 4 prong power cable plug.

The procedure just outlined sounds very simple and easy. A number of problems arise when the tube filaments are connected in series. This is especially true when the plate current of the tubes is great enough to alter the filament voltage when it passes through the filaments on its return path to the "B" battery.

The following must be given consideration:

1. The filament current drain must be the same for each tube if they are to be connected in series.
2. Suitable shunts must be provided to bypass plate currents around the tube filaments.
3. The grid of the power tube must be returned to the most negative end of the filament series, to obtain the required maximum—4.5 volt grid bias.
4. The AVC grid returns should be

changed, as when tube filaments are in series, additional fixed bias is automatically obtained on certain tubes.

SERIES FILAMENT HOOKUP

Practically all of these sets use a 1R5 converter, 1T4 I.F., 1S5 detector, AVC and 1st audio, and a 1S4 power tube. Refer to the July, 1941 issue of *Radio-Craft* for the schematic of the Crosley set and also the Zenith. Reference should also be made to the October 1940 issue of *Radio-Craft* for the schematics on the RCA, Emerson and "Tom Thumb." Since the filament of the 1S4 tube draws 100 MA at 1.4 volts, it cannot be connected in series with the other tubes which draw 50 Ma. at 1.4 volts. The 1S4 must then be replaced with a 3S4 which has the same characteristics except that the filament draws 50 Ma. at 2.8 volts. The filaments can now be connected in series but an "A" supply of $3 \times 1.4 + 2.8 = 7$ volts @ 50 Ma. will be required. This can readily be supplied by 5 pen-light cells connected in series. These pen-light cells, by the way, are easier to obtain than the regular 1.5 V. flashlight cells. The 45Z3 rectifier tube for the power supply will furnish this amount of current plus the 11 mils @ 67.5 volts for the "B" supply without any trouble.

FILAMENT SHUNT RESISTORS

When the filaments are connected in series the plate current from each tube must pass through the filament of the proceeding tubes to complete its path back to the "B" of the "B" battery. This means a very heavy current will pass, especially through the last tube filament (in this case the 1S5) and in order not to damage the filament the plate current must be by-passed. A clearer picture of this action can be obtained by referring to Fig. 1A which shows the regular parallel filament connections (only plates and filaments are shown to simplify the schematic). Note that the "B" current does not pass through the filaments at all. Fig. 1B shows the filaments connected in series and shows that the plate current (plate and screen) of the 3S4 passes through the filaments of the 1T4, 1R5, 1S5 and then back to the "B" supply. The filament of the 3S4 plus that of the 1T4, while the filament of the 1S5 carries the plate return current of the 3S4, 1T4 and the 1R5. The approximate method of figuring the values of the shunts to by-pass the plate currents is as follows: To by-pass, say, 5.25 mils from the 3S4 will require:

$$5.25 = \frac{1.4 \times 3 \times 1000}{R}$$

$R = 800$ ohms. Connect as shown in Fig. 1C.

Since the plate current of the 1T4 is only around 2.5 mils we will not by-pass it with a separate resistor but will by-pass it and the plate current of the 1R5 together by means of a shunt across the 1S5 filament. If the combined plate current of the 1T4 and 1R5 is say 4.67 mils then the shunt

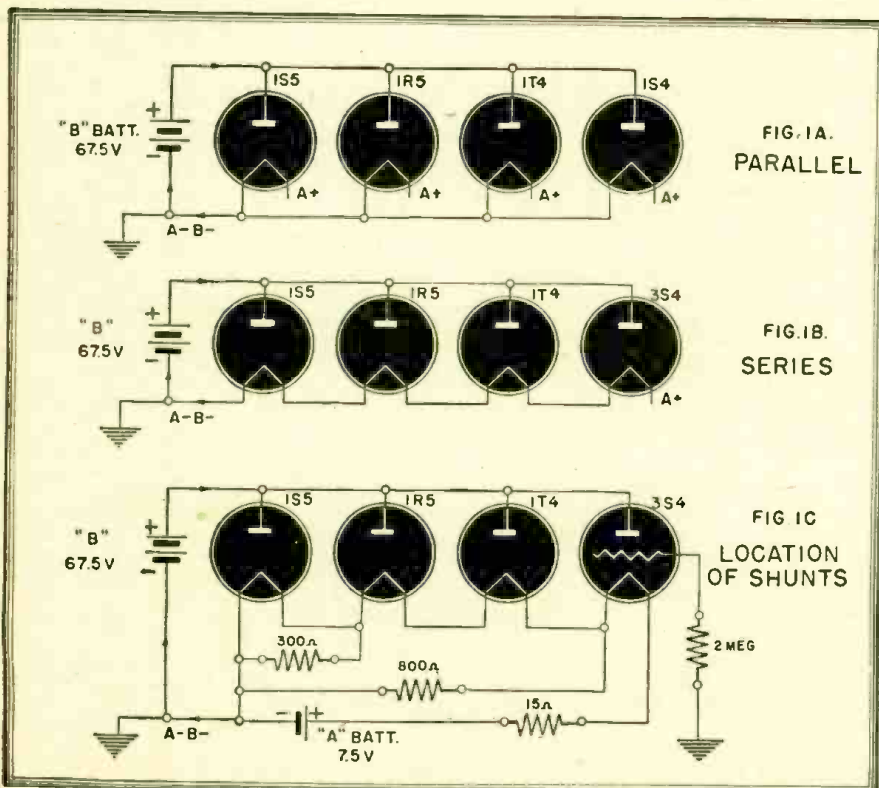

Fig. 1—Shunts are necessary to prevent a filament overload by the heavy plate currents.

required is readily calculated, as follows:

$$I = \frac{E}{R}, \quad 4.67 = \frac{1.4 \times 1000}{R}$$

$$R = \frac{1400}{4.67} = 300 \text{ ohms.}$$

Note: In using Ohm's law, if the current is in mills the voltage must be expressed in millivolts which is 1000 times the value of E in volts. The value of the shunt R is, of course, in ohms.

The terminal voltage on some of the pen-light cells is 1.6 volts so it is well to place a 15 ohm 1/2 watt resistor in series with the A+ lead as shown in Fig. 1C. This will reduce the total filament voltage about 0.75 volts. The 800 ohm bias resistor on the 1S4 must be removed. It can be used as shown in Fig. 1C for the 800 ohm shunt. The 300 ohm 1/2 watt resistor used to shunt the 1S5 filament will have to be purchased.

GRID BIAS AND AVC

The grid bias for the power tube was formerly produced by the voltage drop across the 800 ohm resistor in the B- lead (Fig. 2). It is now obtained by connecting the grid return of the 3S4 to the A-B- or most negative point in the filament circuit (See Fig. 1C). This gives a -4.5 volt bias between the grid and F- of the 3S4. (This does not apply to GE and Sentinel personal portables in which the bias is obtained from a filtered voltage taken from the oscillator grid of the converter tube. See schematic of Sentinel Model 227-P in the February 1941 issue of *Radio-Craft* for this biasing method.)

Refer to Fig. 2 which is a partial schematic of the set showing all grid returns, filaments and battery connections and note that the grid returns of the 1R5 and 1T4 are both connected to the 3 meg filter resistor of the AVC source. For the complete schematic refer to the July 1941 issue of *Radio-Craft*. In this connection it should be noted there is a mistake in the schematic. The Nos. 4 and 6 grid prongs of the 1R5 should be interchanged to correct it. This correction has been made in the partial schematic of Fig. 2.

It is good practice to keep the detector at ground potential, so the filament of the 1S5 detector was grounded as shown in Fig. 1B or C when the filaments were connected in series.

If the grid return of the 1R5 is not changed the bias on the 1R5 is the AVC bias plus the -1.4 filament voltage of the 1S5 detector. The bias on the 1T4 tube is the AVC bias plus the -1.4 filament voltage of the 1S5 plus the -1.4 filament voltage of the 1R5. This gives us a -2.8 volt fixed bias plus the AVC bias for the 1T4 tube. This is automatically brought about when the tube filaments are connected in series and is not due to any changes in the grid returns. The radio will operate with this much bias on the 1T4 but it will perform more satisfactorily if the grid return is not connected to the AVC bus but is returned directly to the negative filament of the 1T4. This gives zero bias on the 1T4 and removes the AVC from it. The 1R5 works satisfactorily with the -1.4V bias on it so no changes are made on it. See Fig. 3 for final schematic of the set showing the changes mentioned in the text.

A.C. POWER SUPPLY

The power supply is conventional and is "hooked up" as shown in the schematic Fig. 3. It is a half-wave unit supplying the 7.5 volts "A" current at 50 MA for the tube filaments and also the 67.5 volts of "B"

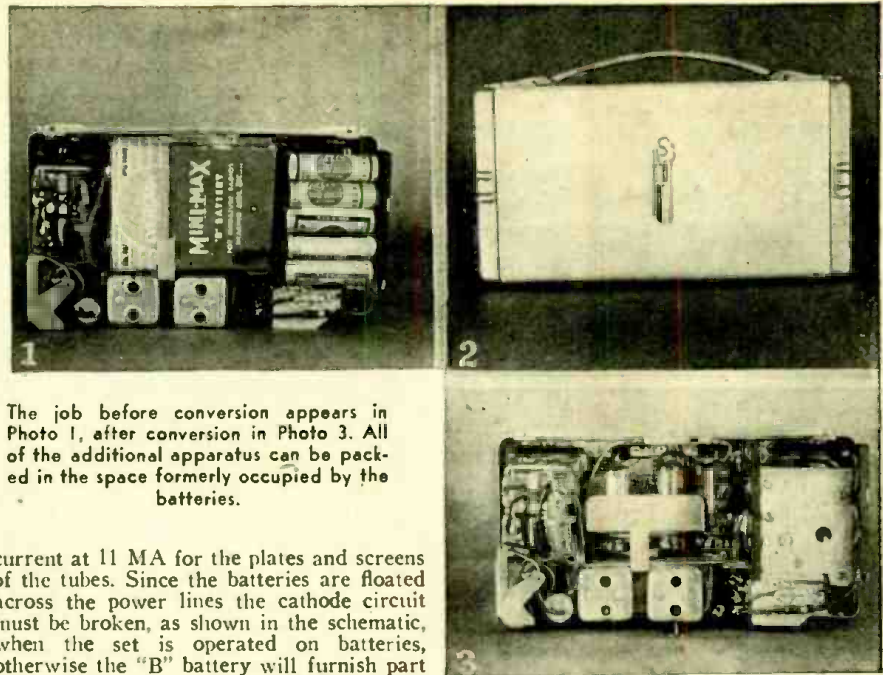

The job before conversion appears in Photo 1, after conversion in Photo 3. All of the additional apparatus can be packed in the space formerly occupied by the batteries.

current at 11 MA for the plates and screens of the tubes. Since the batteries are floated across the power lines the cathode circuit must be broken, as shown in the schematic, when the set is operated on batteries, otherwise the "B" battery will furnish part of the filament current through the voltage divider system. This will amount to a 10 MA extra drain on the "B" battery. Instead of using a switch, which would take up too much space in the set, the cathode circuit is broken by pulling out the 4-prong plug which connects the power cable to the set. Prongs 2 and 3 on the plug are wired together and when the plug is removed the circuit is broken. The position of the 4 contact socket in the end of the case is shown in the photographs.

LOCATION OF PARTS

The location of parts is shown in the two photographs which are rear views with and without the batteries. The space originally occupied by the 10 MFD condenser connected from B+ to ground is now occupied by the 45Z3 rectifier tube. The 10 MFD condenser is not used in the revised circuit. The 1000 ohm filament dropping resistor for the 45Z3 tube is on the end of the radio close to the output transformer and does not show in the photograph. The 25,000 ohm adjustable resistor in the "A" supply is located close to the volume con-

trol. The end of it can just be seen in the photo. It is mounted on a small piece of bakelite and fastened with two screws to the metal plate supporting the volume control. This resistor is adjusted to give 1.4 volts on the tube filaments. A special holder made from bakelite strips and old 201A tube socket springs is mounted on the back of the speaker plate to hold the 5 pen-light cells in series connection. The batteries are easily snapped in place and held there by the contact springs. The round headed screws in the speaker plate must be replaced with flat-headed ones to make room for the batteries. All filter condensers and the 3,500-ohm "B" supply resistor are located in the space which was previously occupied by the 1.5 volt "A" battery.

While the wiring is not difficult the schematic should be carefully studied and all connections located on the set itself. It would be wise to first trace the wiring of the set and make your own schematic. In this way, all connections can be located. This will result in a minimum number
(Continued on page 630)

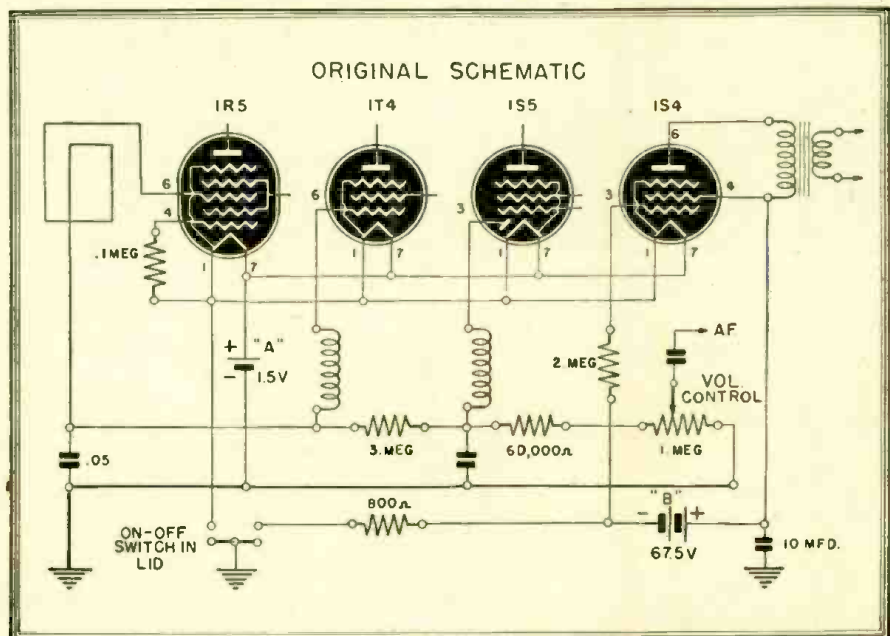

Some parts of the original diagram, showing the grid returns and biasing system.

So You Think You Know Electronics!

This will be a good test for even the best radio—electronic engineer and others who think they know their electronics. Answers on page 640

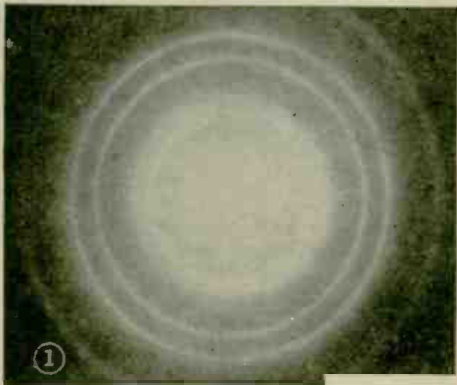

1

1—What does this electronic halo represent?



2—Is this strange-looking instrument an electronic turbine, or what is it?

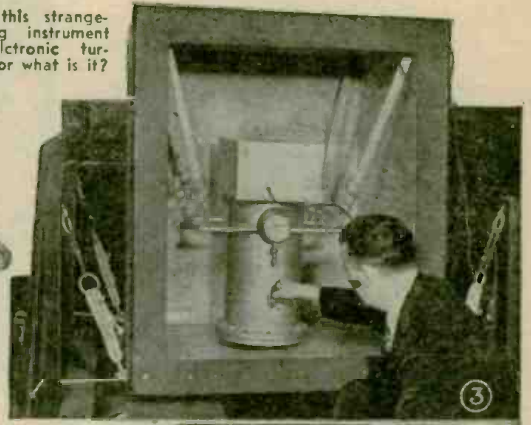

3

3—You know your "ropes"? Then what goes on here? 6—An electronic turnstile?

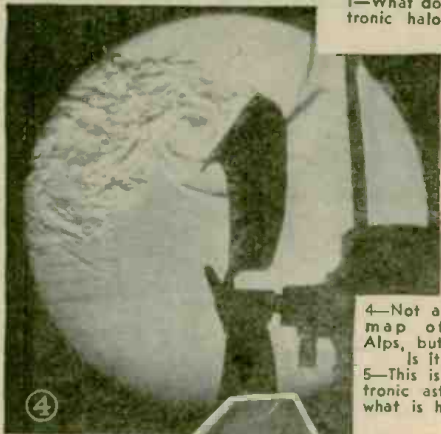

4

4—Not a relief map of the Alps, but what is it?

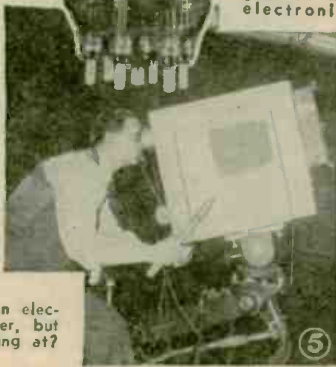

5

5—This is not an electronic astronomer, but what is he gazing at?

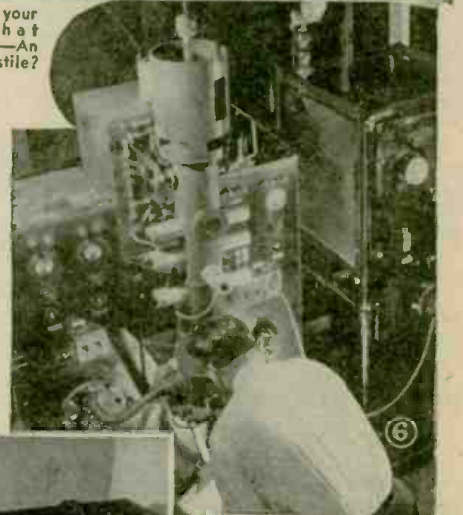

6

7—This might be an electronic "cabinet" minister, but explain the screwy cabinet. 8—Not a Nazi double-barrel cross-channel gun, but what is the engineer up to?



7



8

9—Not electronic saltshakers, but what can they be?



9

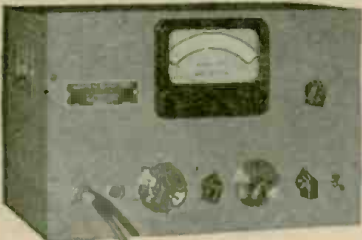

10—Not another electronic mouse-trap, but what is it?

10

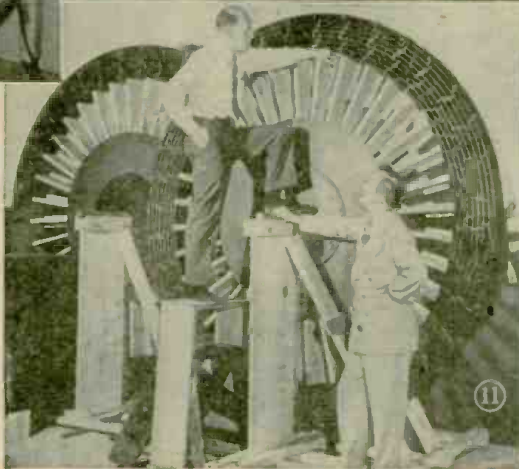

11

11—If this is an electronic wheel of fortune, then where are the numbers?

12—This may be easy. Can you find out what's cooking here?



12

U. S. OWES DEBT TO RADIO "HAMS"

By LARRY LeKASHMAN

THE art of communication is the eyes and ears—the whole nerve system—of modern warfare. The speed with which American military communications caught up with and surpassed those nations which had been mobilized since 1939 is one of the wonders of the present war. As is usual in "miracles" there was a good sound underlying reason, often overlooked by the public. That reason is the radio amateur. Of all the warring powers, the United States was the only one which started out with several divisions of highly trained and disciplined radio technicians.

The average ham is an operator infinitely superior in his ability to copy an all-but-inaudible station through thunderous local interference or enemy jamming; a constructor and experimenter whose discriminating taste and exacting demands have forced the manufacturers of American radio equipment to a point of progress unknown to the rest of the world; a research worker who, with attic-workshop apparatus for the most part, has nevertheless succeeded in keeping comfortably ahead of the fantastically-outfitted laboratories and research departments of the greatest radio corporations; and a trained and disciplined communications man who could step from his Army and Navy amateur nets directly into the armed services without hesitation or confusion.

It is the ham of yesterday who is the expert communications man of today. The hams filled the ranks at the outbreak of the war; they were the vital link until hundreds of thousands of operators and technicians could be trained. The radio amateur provided the instructors, the officers, and the "know-how"! As an example, the Army Airways Communications System, an outstanding achievement of this war, is the work of amateurs given the task of setting up the communications network for the far flung air corps. The Merchant Marine, the CAA, the air transport systems, in fact every user of trained radio personnel, was tided over the most critical period in our nation's history by the reservoir of men and women whose peace time hobby was radio. (It would be unwise to lose sight of the hobbyists who were not licensed, but still contributed to the job done.) Every hour of practical experience the radio amateurs had in their stations and shops, building, studying, operating and investigating, was

A typical pre-war amateur transmitting and receiving station. It was from posts like these that Uncle Sam recruited the world's best-trained group of communications men.



worth tenfold in man hours to the war effort. No amount of formal schooling can instill the same practical knowledge these individuals acquired.

It was common knowledge that the new graduates of the intensive training courses might be able to copy 35 words per minute with ease, but cracked up immediately when even moderate interference appeared. The ham, who never feels at home unless the station to which he is listening is buried under four louder ones, was of course in his element under such conditions. Though his code speed may never have exceeded 25 per, he was worth three of the new high-speed wonders under actual wartime operating conditions.

The value of the radio amateur cannot be measured only in terms of their direct contribution as individuals, which in itself has earned them the everlasting gratitude of every American. It was the radio amateur who supported the greatest arsenal of radio in the world. Many of the radio contractors of this war are organizations that would be non-existent were it not for the ham. There was little public market outside of the amateur field for the products of almost all the producers of short-wave equipment. These were the companies who answered the call to do the "impossible." The exacting demands of an enlightened customer forced the manufacturer to produce superior merchandise in competition with others in the same amateur supported field. This is the gear which is now paying off! America was prepared to win the war of radio and electronics because the radio amateur had already provided the basic facilities. Left to drift under conservative military departments, foreign apparatus underwent no such development, with the result that German radio apparatus is stated to be five years out of date, and Japanese equipment is "a good imitation of 1939 American ham radio."

The day America went to war the military services requisitioned all amateur frequencies. To those who may view this as

unimportant, a brief look at the present frequency assignments will immediately show that existing commercial services are so located that there are few large blocks of frequencies available. The confusion and accompanying disruption of service at that critical time might have been catastrophic had the military services found it necessary to shuffle frequencies to find space for their own thousands of stations. Such a drastic step was not required, as the amateur channels were at once available. The amateur frequencies therefore may always be looked upon as a reservoir of space in the radio spectrum for any emergency in war or peace, as the amateur himself is a reservoir of trained technical manpower.

During peace time, the hams are likely to appear in the public eye only during floods, tornadoes or similar disasters, when they invariably serve with distinction. In emergency after emergency, from California quakes to New England floods, it was the radio amateur who first provided vital communications. In many instances, press dispatches dated with the press service by-line were transmitted only because of ham stations. The service rivaled the fastest commercial telegraph systems to all parts of the country.

The Army Amateur Radio System and the Naval Communications Reserve were ham organizations. WERS, the War Emergency Radio System, which is providing radio for the civilian volunteer units, is very largely the work of amateurs. With

(Continued on page 622)

KEY FOR CHART

- | | |
|-----------------------|--|
| F—Fixed station | GC—General communications |
| G—Government station | IB—International (short-wave) broadcasting |
| CT—Coastal telegraphy | Px—Press stations |
| Sh—Ship telegraphy | T—Television |
| B—Broadcast | MP—Motion picture |
| P—Police | F—Forestry |
| RB—Relay broadcasting | Exp—Experimental |
| Av—Aviation, aircraft | SS—Special services |
| C—Coastal and harbor | SE—Special emergency |
| ShP—Ship telephony | |

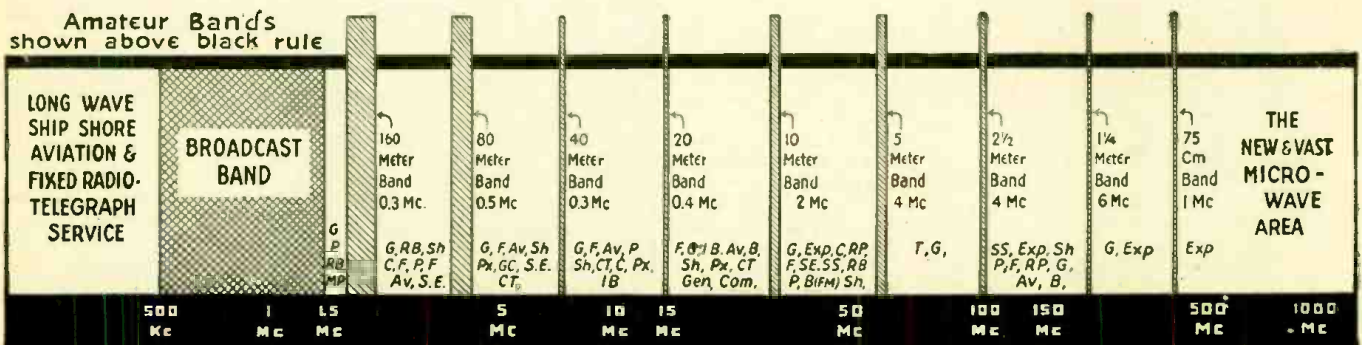

MEASURING CAPACITY

By I. QUEEN

UNTIL very recently the subject of capacitance measurement has been rather neglected in radio publications, condenser testers usually taking the form of leakage or short indicators only. With commercial apparatus capable of measuring capacitance off the civilian market for some time, technical information on this subject is important to the serviceman and technician.

Fortunately, however, several articles on this subject have recently appeared. February *Radio-Craft* described a tester using the resonance principle (for very low capacitance values) while the May issue gave details of design for a bridge circuit which would check not only condensers but resistors and inductors as well.

This article is concerned with methods whereby capacitance may be indicated on an A.C. or D.C. milliammeter or A.C. voltmeter. Either the meter face may be directly calibrated or the indication may be made to coincide with a prepared chart. Properly designed meters of the types to be described may be relied upon to within 2% accuracy, and the measurement may be quickly made so that a good deal of time is saved. Three general methods will be discussed, each requiring a different type of meter generally available to the radio man.

The accompanying table (Fig. 2) shows what to expect from this method. An ordinary Triplet type microammeter (with proper shunts) was used in obtaining these results. Note that larger deflections are obtained when using higher capacitances or higher voltages. Note especially the excellent LINEARITY which may be obtained with different voltages. This means that only a few values need be calibrated,

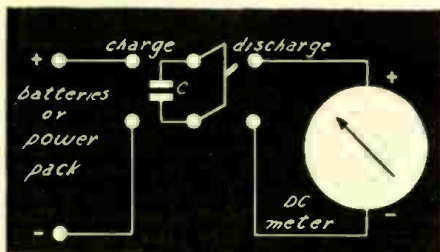

Fig. 1—How condensers are measured by the ballistic method. Table of currents below.

Cap.	Voltage	Microamp.
16 mfd.	1.5	300
	3.0	600
	4.5	900
30 mfd.	1.5	520
	3.0	1040
1 mfd.	1.5	15
	3.0	30
	4.5	45
.1 mfd.	10	6
	20	12
	45	28
	90	56
	135	84
.05 mfd.	180	112
	90	29
	135	43
180	56	

Fig. 2

THE BALLISTIC METHOD

This method is often used in the laboratory for measurement of capacitance of transmission lines. Fig. 1 shows the set-up. First we charge the unknown condenser to a definite voltage E (direct current) which may be of any value less than the breakdown voltage of the condenser. If we use the maximum voltage permissible with the given condenser we automatically check for breakdown, also.

After a second or so, the switch is thrown to "discharge," and the total quantity of electricity on the plates now passes through the D.C. microammeter (or milliammeter). The meter kicks upwards to some value and then returns to zero.

This method is often used with a "ballistic" or weighted movement type of meter. Strictly speaking, only the ballistic type will actually measure the total quantity of electricity in the condenser, because the total effect of every electron passing through has a bearing on the final indication. In other words, the condenser is fully discharged before the maximum swing is reached.

This type of measurement can, however, be used very successfully with an ordinary D.C. microammeter or milliammeter. A low leakage toggle switch (possibly the spring-action type which snaps up when released) can be used to good advantage here.



Fig. 3—An ordinary business card used as an optical shield for reading peak values. Fig. 5—Milliamperes plotted against microfarads, for use with the circuit of Fig. 4.

Photo courtesy Triplet Electrical Instrument Co.

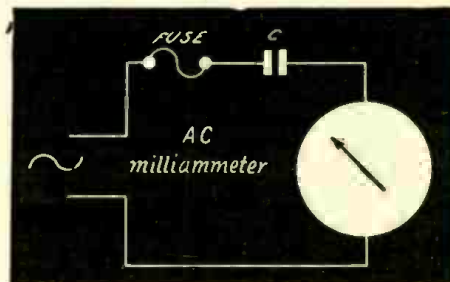

Fig. 4—A.C. milliammeter as capacity meter.

and all others obtained by drawing a chart on linear squared paper. The graph will be a STRAIGHT LINE, so that it is possible to use whatever D.C. source is available.

While this linearity results with a change of voltage, note that a change of capacitance is not quite linear, although very nearly so. With a sensitive microammeter, a condenser of .005 mf. may be measured conveniently with a voltage of about 90. High capacitance condensers offer no problem and may be accurately indicated with very low voltages as shown. This is especially interesting in the case of low-voltage high-capacitance electrolytic filters upon which only a few volts may safely be impressed.

Since the condenser charges to the open-circuit voltage of the applied source within a short time, a new battery does not have to be used, nor is a voltmeter an absolute necessity, unless the highest order of precision is required.

Due to the fact that one quick swing of the pointer takes place, after which it settles back to zero, it is essential that the maximum indication be accurately noted when high precision is needed. For this purpose an optical shield may be used. This merely consists of a card which is used to cover part of the scale, as in Fig. 3. When we find a position such that the needle is just visible during a measurement, the card is evidently pointing to the maximum reading

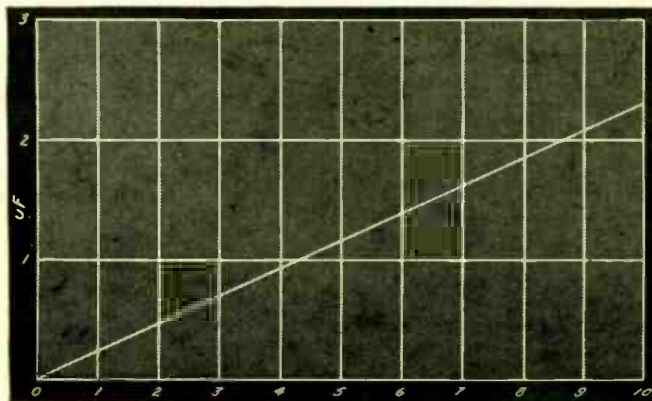

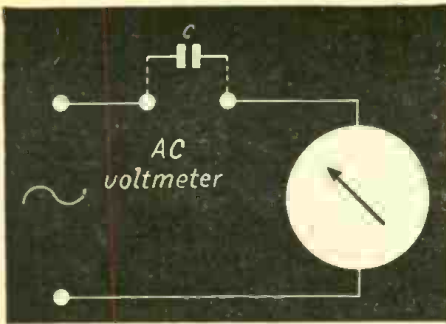

Fig. 6—An A.C. voltmeter is used instead of a milliammeter in this circuit. No fuses are necessary if the meter is selected to read full-scale if placed right across the line.

and therefore corresponds to the desired result. Several tries may be necessary if extreme accuracy is required.

It may be pointed out here that the ballastic method is based upon the formula $Q = C \times E$, where the units are coulombs, farads, volts. A properly-designed "ballastic" meter reads in terms of coulombs or millicoulombs and would therefore be linear throughout the range.

This type of measurement actually indicates several characteristics of the condenser under test: capacitance, by maximum swing; breakdown, by no reading (with no danger to the meter itself); leakage, by a much lower reading when the condenser is left to stand for a short while between "charge" and "discharge."

By observing polarity, electrolytics may conveniently be measured in this manner.

A.C. MILLIAMMETER METHOD

The circuit is shown in Fig. 4. The unknown condenser is connected in series with the meter and a known source of alternating current, for instance the line. It is wise to fuse the circuit. Lower readings correspond to lower capacitances. The face of the meter may be calibrated in capacitance units for direct reading or reference may be made to a chart as in Fig. 5.

The chart shown is applicable to 115 volts, 60 cycles. (For any other frequency—such as 50 cycles—we may read off the chart as before and multiply the result by 60 —, etc.) Other voltages of the same frequency give proportionate indications. For example, 11.5 volts, 60 cycles, would give a reading only 1/10th as large as would 115 volts, for the same condenser.

While the chart shows readings only from 1 to 10 milliamperes, extension to lower or higher ranges is easily accomplished. If the indication is 25 ma., the condenser being measured is 10 times as large as is indicated for 2.5 ma., and so on. The same holds for lower readings, 25 ma. indicating a condenser one-tenth as large.

Fig. 7—The Weston 664, a commercial model working with A.C. Condensers of widely varying capacities may be measured on its scales.

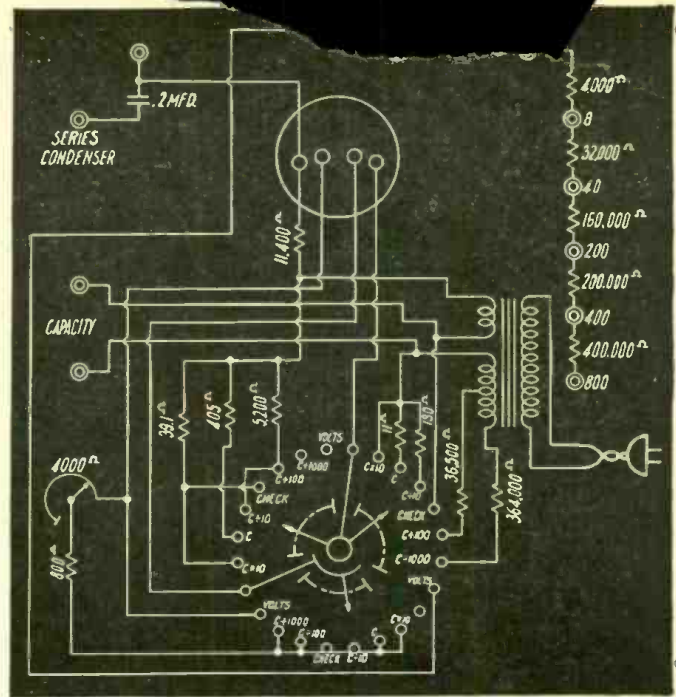

This method is based upon the fact that the capacitive reactance of a condenser is given by $X_c = \frac{10^8}{2\pi f C}$ (C in microfarads),

and that $I = \frac{E}{X_c}$, disregarding fuse and meter resistances. This gives $I = \frac{E 377 C}{10^8}$

(I in ma.). When E = 115 volts, $C = \frac{4336}{I \text{ (ma.)}}$

This may be simplified to $C \text{ (mi.)} = \frac{4336}{I}$ which is a straight line when plotted.

A.C. VOLTMETER METHOD

This method is illustrated in Fig. 6. It requires no fusing, since the voltmeter is first adjusted so that it reads full-scale when the terminals are shorted. Short-circuit is then equivalent to infinite capacitance. As in the two previous methods, larger capacitances show greater deflections. The circuit and scale of Fig. 6A are from the Philco model Q26 circuit tester.

Another typical capacitance-measuring meter is the Weston 664, circuit of which is shown in Fig. 7. This is a more elaborate unit, having five ranges for capacitance "—1000," "—100," "—10," "C," "C × 10" (be-

sides other ranges for A.C. volts). The face is calibrated from 0 to 20 mfd., so that readings may be obtained from .0001 to 200 mfd.

The basic A.C. meter used in the Weston 664 has a full scale of 1/4 ma. The multiplying ranges are obtained by suitably shunting the meter so that it reads higher values at the higher ranges. At "C × 10" the meter read 100 ma. full scale. For the higher reading scales the impressed voltage is reduced. For the lowest scale it is almost 100 volts, while for the highest it is but 4 volts, a small transformer being used for the stepdown. Isolation of the line voltage is used on all ranges and is a desirable feature.

The technical reader will now pose the query: "Calibrated condensers are not usually available. Is there some way that I can calibrate a scale for capacitance reading without the use of standards?" There is a simple procedure by which this may be done. It is only necessary to know the value of the voltage source and the total resistance in the circuit.

First, draw a circle of diameter equal to the voltage source (in any units). As a practical example, we will take E (Fig. 8-a) to be 100 volts. We may therefore draw the diameter 2 1/2" (20 volts per half-inch). Now we wish to find what capacitance value corresponds to, let us say, 80

(Continued on page 635)

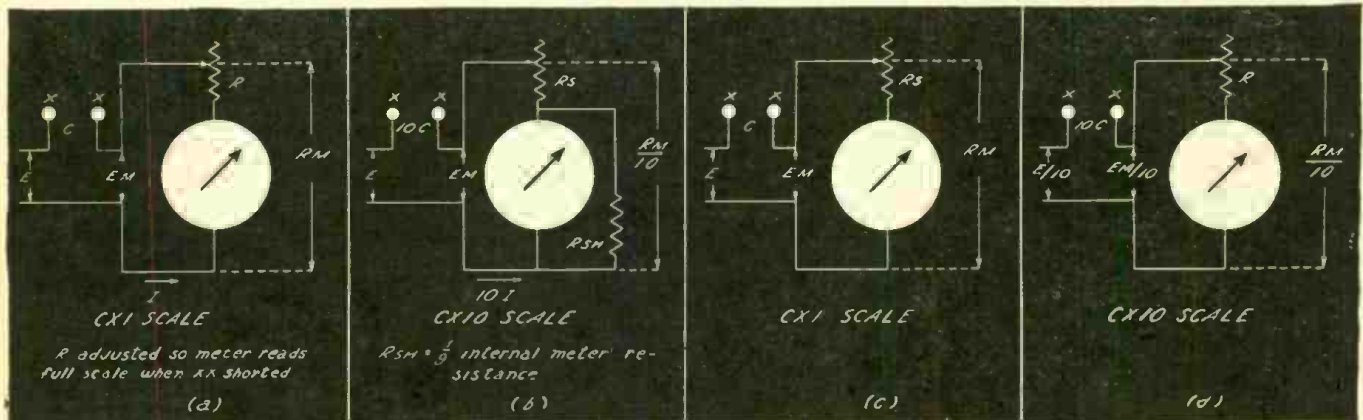

Fig. 8—A single meter may be used to measure a wide range of capacities, by the use of shunt and series resistors, as shown above.

CATHODE-RAY TUBES

ONE AMONG THE MOST IMPORTANT OF TODAY'S ELECTRON-TUBE FAMILY

THE cathode ray tube is a device which is capable of measuring the effect of an electro-static or electro-magnetic field. It is "a meter with an electronic pointer," and therefore has many advantages over the ordinary type. For instance, overload can have no effect on the pointer itself. Also the weightless electronic beam pointer has negligible inertia and so can follow almost instantaneously a given impulse. The scope can also be used to provide simultaneous indications in more than one

By NATHANIEL RHITA

direction. This is useful for many purposes.

Fig. 1 gives a general sketch of the instrument. A filament is used to heat the cathode for electron emission. These two elements are usually tied together internally. The grid controls the intensity of the electron beam as in other electronic tubes. ("Grids" in cathode-ray tubes are usually in the shape of cylinders or rings, through the centers of which the electron stream passes. They are quite commonly called accelerating electrodes rather than grids.)

The focusing electrode A is supplied with a high positive voltage, the effect of which is to condense the beam so that only a narrow stream of electrons moves. The very high positive voltage on anode No. 2 (which is grounded) serves to accelerate the beam further.

By this time the electrons are moving along the tube axis at a very high speed. They strike the screen of the tube, giving up their energy and causing a fluorescence due to the interior screen coating. The color of the light given off depends upon the type of coating used. Available colors include yellow, green, white and blue. For photographic use, the scope screen may be coated with a material of high actinic value.

As described so far, the electron beam will be a small spot in the center of the screen, the intensity being controlled in accordance with the grid bias used. However, when voltages are applied across the deflecting plates, a different state of affairs takes place.

Figure 2 shows the electron stream passing between a set of parallel plates. Since an electron possesses negative charge as well

as inertia, it obeys certain universal laws of mechanics and electricity. It will, for example, be attracted by a positive charge and repelled by a negative one. As shown, then, the force due to the plates accelerates the electron towards the positive plate, the force being effective during the period of time that the electron is passing between the set of plates.

The longer the plates the greater the final displacement of the beam. However, the length of plates must not be comparable with the wave length of the A.C. under measurement, nor must they be long enough to be in the path of the deflected stream of electrons.

An elementary analysis of the path of motion will be given here for the technical reader. Looking at Fig 2, we have the displacement from the elementary laws governing constant acceleration

$$a = \frac{F}{m} = \frac{Eq}{md} \text{ and } t = \frac{h}{v}$$

where E is the potential between plates, m is the electronic mass and q is its charge and v is the electron velocity. F and t are of course, force and time, and d, h and L appear in the figure.

$$BC = \frac{1}{2} at^2 = \frac{Eq h^2}{2md v^2}$$

After leaving the influence of the plates, the electron travels along a straight line, so that if its path were along the line A.C. it would suffer a total deflection on the screen

of $\left(\frac{Eq h^2}{2md v^2}\right) \left(\frac{L}{h}\right)$ However, the path

is in reality a parabola (just as any falling object) and therefore the slope of its parabolic path at C is exactly twice that of the straight line A.C. The final displacement of the spot is therefore

$$\frac{Eq h L}{md v^2}$$

The tube can thus be used as a D.C. voltmeter. We merely need know its sensitivity, say in volts per inches displacement since the deflection is uniform. If A.C. is applied across a set of plates, the beam will be rapidly and continuously deflected, as the voltage increases and decreases, and due to optical persistence, we would see a straight line, again giving an indication of voltage. It is important to note that the maximum value of the voltage concerned is indicated in all cases. The inner set of plates will evidently be slightly more sensitive than the other set.

Used in this manner, many of the possible advantages of the inertia-free pointer are lost. Though the electron beam marks the exact voltage at any given instant of the cycle, the persistence of vision and that of the phosphorescent material of the screen result in a line only being seen. By combining a means of moving the spot horizontally while the impressed voltage is moving it vertically, we can follow regular or irregular A.C. waves throughout each part of their cycles. The instrument which combines periodic horizontal deflection with the vertical movement of the electron spot is called a cathode-ray oscilloscope. As the oscilloscope—or scope as it is called—illustrates excellently the operation of the

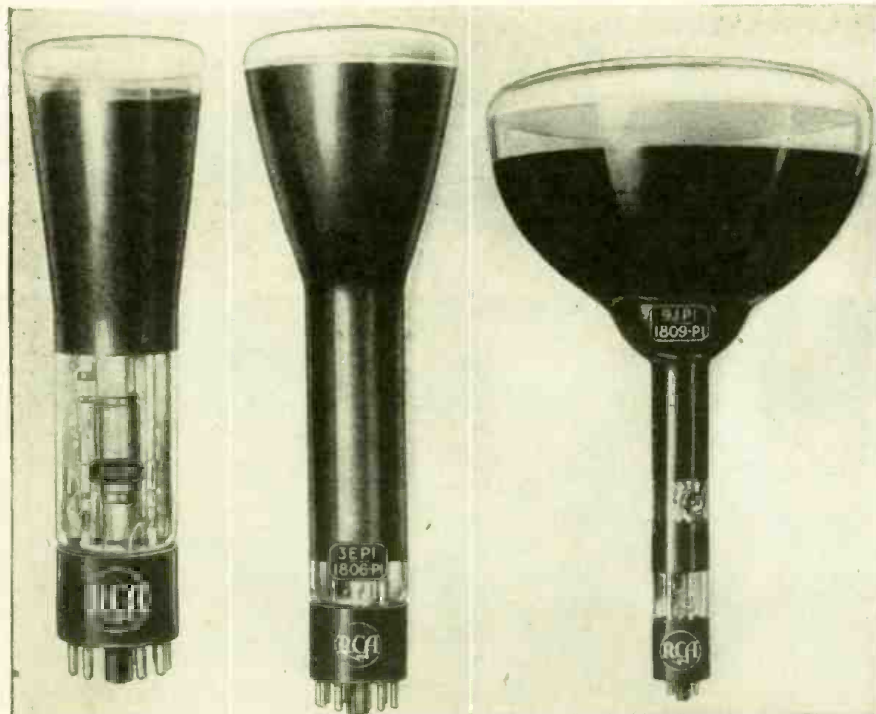

A number of typical cathode-ray tubes. The one at right is a magnetically deflected type, intended for use with external deflecting coils. This kind of tube is used in television.

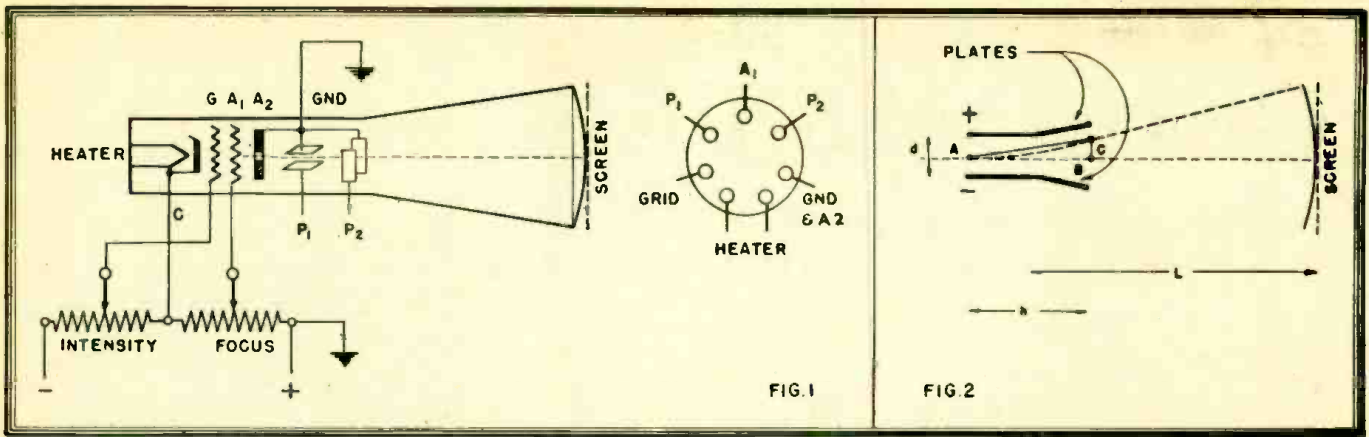

Fig. 1—Construction of a typical electrostatic cathode-ray tube. Base shown at right. Fig. 2—How the plates bend the cathode ray.

cathode-ray tube, we will consider its method of operation.

The real usefulness of the scope lies in its ability to "spread out" the wave to be studied. One set of plates is connected to the input to be studied, while the other set may be connected as the time element axis. For convenience, the latter may be a linear or "sawtooth" oscillation. This is a deflection which varies uniformly in a certain time from one end of the screen to the other and is suddenly snapped back to the starting place (Fig. 3).

Fig. 4 shows a schematic of a linear sweep. A gas-filled tube such as the 885 thyratron is used with a resistance-capacity circuit. The characteristics of this tube are such that breakdown or "flashing" occurs when the positive plate voltage bears some ratio to the negative grid voltage. This ratio is fairly constant over a wide operating range (about 7 for the 885).

Operation takes place as follows. The D.C. voltage charges the condenser until the flashing point is reached. The thyratron breaks down, allowing the condenser to discharge at once, whereupon the cycle repeats. A wide range of frequencies is obtained by switching in different sizes of condensers. A fine adjustment is made by variation of the Frequency Control resistor.

An important consideration in the design of linear (sawtooth) oscillators is the relationship existing between condenser, resistor and voltage source for a truly uniform charging current.

When a condenser is connected in series with a resistor across a constant source of voltage E , the condenser voltage at any instant may be put in the following form:

$$E_c = E \left(\frac{t}{RC} - \frac{t^2}{R^2C^2} + \frac{t^3}{R^3C^3} \right)$$

(See Fig. 5)

For a perfectly uniform sweep this voltage must be proportional to time. This will evidently happen when we neglect all terms but the first, which means that we require large values of R and C or small values of the numerator (t). The condenser must then be charged to a very small percentage of the applied voltage. It is common to specify less than 10%, the smaller the better. The resulting small voltage peak may, of course, be amplified by suitable horizontal amplifiers.

The frequency of the sawtooth frequency may be found as follows: From the formula given in the previous paragraph, we

$$\text{have } E_s = E(t/RC). \text{ This gives } t = \frac{RCE_s}{E}$$

as the time for one cycle, where E_s is the voltage rise in the condenser, that is, the difference between flashing potential and ionization potential. The frequency is ob-

$$\text{tained at once } f = \frac{E}{RCE_s} \text{ (C in farads).}$$

In order that the observed pattern may appear stationary, it is necessary that the linear sweep be started at the very same instant that the wave under study reaches the horizontal axis and starts to rise. To accomplish this, a small portion of the input voltage is applied to the thyratron input. This causes the flashing to take place at the correct moment.

If input and sweep voltage frequencies are equal, one cycle will be observed. If the former is exactly twice as great, two will be seen, etc. If one is a small harmonic of the other, synchronization will still be obtained as explained before.

When a sine wave is applied to the horizontal plates instead of the linear sweep, other types of patterns appear. When the

two frequencies are equal, we see a straight line, an ellipse or a circle, phase and magnitude determining the image.

A few simple patterns may be discussed here. When both vertical and horizontal EMFs have the same frequency and magnitude and are in phase we write

$$\begin{cases} y = A \sin wt \\ x = A \sin wt \end{cases} \text{ or } y = x \text{ a straight line.}$$

If the magnitudes are unequal, the line will deviate from the 45° angle. This is an excellent method for comparing magnitudes of two in-phase voltages of the same frequency.

When the two voltages are 90° out of phase we put

$$\begin{cases} y = A \sin wt \\ x = A \cos wt \end{cases} \text{ or } \frac{y^2}{A^2} + \frac{x^2}{A^2} = 1$$

a circle of radius A , so that the magnitude of two out-of-phase equal voltages is known by measurement. When the two are not of equal magnitude, we see that an ellipse

$$\text{results, } \frac{y^2}{A^2} + \frac{x^2}{B^2} = 1. \text{ The axes will be}$$

proportional to the magnitudes of the voltages.

The oscilloscope is often used for comparing frequencies. When one frequency is known, we can easily determine when the other is some multiple or sub-multiple of it. The pattern will be stationary since it repeats after a given time. The number of loops obtained give the ratio of the unknown to standard frequency.

Oscilloscopes may be used to find the degree of modulation of a transmitter. The modulated R.F. is applied to the vertical plates, a linear sweep to the horizontal.

(Continued on page 640)

Fig. 3—Sawtooth waveform of sweep circuit. Fig. 4—Circuit of a linear sweep oscillator. Fig. 5—Operating portion of charging curve.

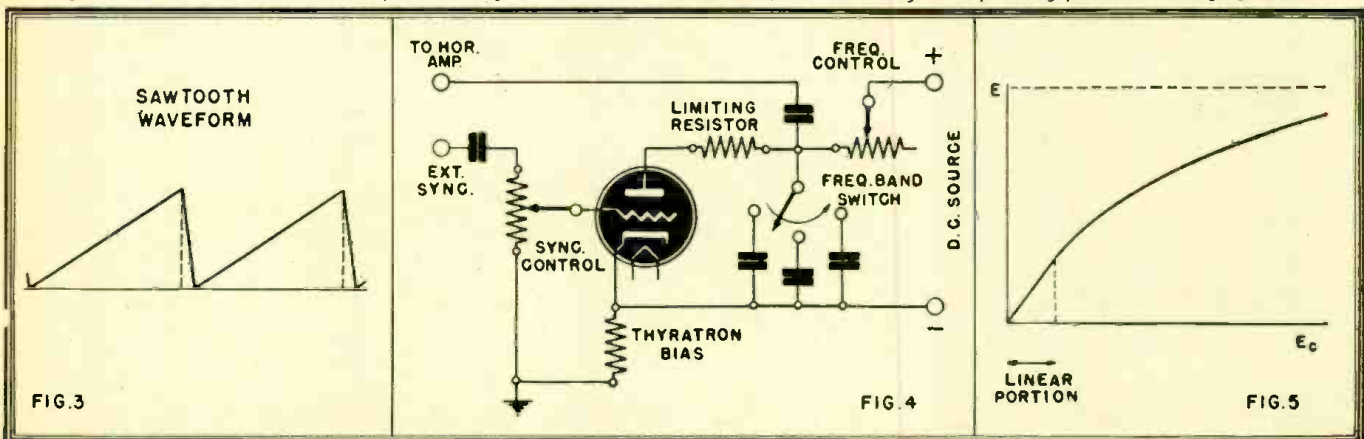

CEILOMETER

Electrons are now used to measure cloud heights as a means of increasing the safety of aviation

It was pointed out in the May *Radio-Craft* editorial that man is at last beginning to do something about the weather. Several instances of man-controlled changes in the weather were mentioned. While probably inevitable, complete control of weather conditions belongs to the future. For the present, man is studying the elements, and if he cannot control them he can at least try to predict their changes so that we may act accordingly.

Various electronic instruments have been developed recently for weather prediction, for instance the balloon device which while ascending into the atmosphere automatically transmits information regarding its environment. It is thus possible to know the temperature, humidity and pressure at various levels up to the maximum height of the balloon ascent. The meteorologist is thus supplied with essential details to carry on his work.

Another important phase in the study of the elements concerns the height of clouds. This not only has a bearing on the weather conditions to be expected in the near future, but even more important, directly affects aircraft safety—especially landing and taking-off.

Former methods employed for this purpose included balloon ascents and reports from pilots in the vicinity. However, it was required that such information also be available during inclement weather. Accordingly, the U. S. Weather Bureau sponsored a project at the National Bureau of Standards, the result of which is the "ceiometer", an electronic device which makes use of the triangulation method for measuring cloud heights.

Ceiliometers have been developed to the

point where the Weather Bureau has purchased a substantial number of them for use throughout the country.

An intense beam is projected upon the cloud base by means of a projector using a 1000-watt G.E. air-cooled arc lamp (B-116) situated in the focus of a parabolic reflector. An automatic pressure switch protects and starts the arc. Including cooling equipment, the arc requires 1500 watts at 120 volts, 60 cycles.

The reflection of the spot on the clouds is picked up by a special optical system and diaphragm mounted in a drum. The image is focussed onto a photocell (RCA 929). Arc lamp and phototube were chosen to be especially sensitive to the same portion of the frequency spectrum. The accompanying photos show the complete set-up.

An important part of the design is the fact that the arc is powered directly from the 60 cycle source. This is not only convenient and economical for arc operation, but it modulates (about 95%) the resultant beam at a frequency of 120 cycles per second. The pickup of the phototube is therefore also modulated at this frequency. This frequency thus acts as the "carrier" for the beam.

The A.C. voltage generated by the phototube is now passed through several stages of amplification, each resistance-capacitance coupled and tuned to 120 cycles. To eliminate noise effects as far as possible, only a narrow band is passed. The amplifier is designed to work under all conditions of weather, so that readings may be available throughout the day and night.

After detection, the signal is passed through a phase shifter and then to a discriminator circuit using two 6SJ7's. The latter plates are fed from the output of an unfiltered full-wave rectifier. This means that the plate currents will rise and fall in accordance with the varying plate voltages. The screens work from a DC source.

The two 6SJ7's are first balanced and then the phase shifter is varied until the incoming signal is in phase with the pulsating plate current. An incoming signal will then cause an increase in one plate current and a corresponding decrease in the other, the potential difference being measured with a vacuum tube voltmeter.

Note that while background reflection from the cloud and miscellaneous electronic circuit noises will also affect the discriminator, these disturbances are not in the correct phase and in a period of time will average out to zero.

In operation the projector directs the pulsating light beam vertically. The ceiliometer pick-up situated at a known distance from the projector, is then rotated until maximum output is shown on the meter. Its elevation angle determines the cloud height.

Where continuous monitoring of cloud height is required, a Selsyn motor is used. The position of the recorder pen on the chart is the result of two motions; the motor determining cloud height and the paper motion determining the time scale. The intensity of the record indicates the intensity of signal received.

The described apparatus can be used to

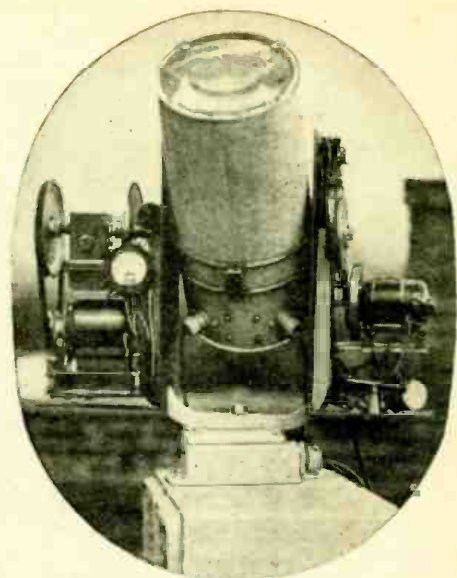

A close-up of the actual pick-up apparatus.

determine cloud elevation up to 20,000 feet in the daytime. Rain and snow ceilings can be accurately measured. Weather conditions have little effect on the ceiliometer, which represents a notable advance in aircraft safety and meteorology.—I.Q.

ATOMIC "VACANCIES" CAUSE RUST

Vacant spaces in the atoms of nickel are responsible for its resistance to corrosion or "rusting," according to Dr. Herbert H. Uhlig, Metallurgist of the General Electric Research Laboratory.

In earlier researches, he found that the stainlessness of stainless steel is not due primarily to the formation on the surface of a film of oxide, as formerly supposed. Instead it results from the electronic arrangement in the atoms of the alloy. Now he finds that the same thing is true for two other widely used corrosion-resistant alloys. One is copper and nickel (Monel) and the other molybdenum, nickel and iron (Hastelloy).

An atom may be thought of as a nucleus around which revolve, somewhat in the manner of planets around the sun, from one to 92 electrons. These move in from one to seven different orbits or shells. Ordinarily one shell is filled with electrons before the next one begins, though in the case of certain "transition" elements there are vacancies in the shell next to the outer one. In nickel, for example, there are only 8 electrons in the third shell, instead of the 10 it could hold, despite the fact that there are two electrons in the fourth and outermost shell. With inner shells completely filled, a metal is more subject to corrosion.

Because of the vacancies nickel is very resistant to corrosion, but it is too expensive for many applications, and so it is alloyed with copper which is lower in cost. The atom of copper has one more electron than that of nickel. In the alloy these extra electrons go to fill the vacancies in the nickel atom. However, as long as any vacancies remain in the nickel the alloy still resists corrosion as well as pure nickel.

According to Professor J. D. Ryder of Iowa State College, there are fewer than 100 men in the United States equipped by training and experience ably to design and apply electronic apparatus to industry in general.

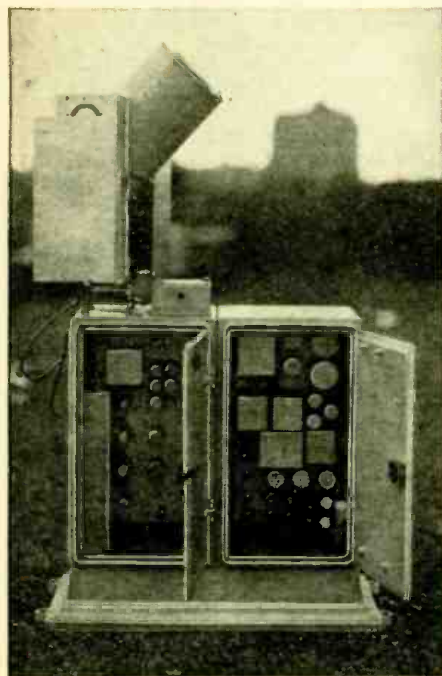

The receiver. How many tubes can you count?

An interesting feature marks the treasure locator pictured at the right. The transmitter and receiver are combined in one pentode-triode tube, giving us a 1-tube locator, the smallest on record.

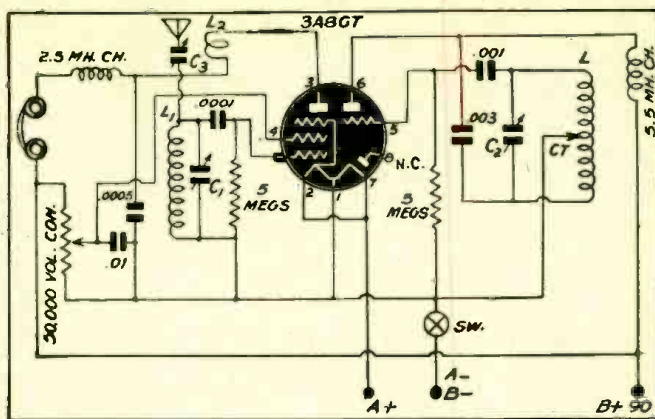

Treasure Locators

With a Description of a New 1-Tube Instrument

By JOHN HAYNES

The author with his new locator ready for a prospecting jaunt.

THE writer has been building and using treasure locators with gratifying results for some 20 years. I have experimented with large and small outfits during this period, have used simple and complicated circuits, and can state that any good locator, properly designed and constructed, will give good results in the location of buried metal. As tubes, circuits and components improve in quality, better results become obtainable with less difficulty.

My first treasure locator used the buzzer system. This was ultra-modern at the time and the circuit was one of the latest and great sensitivity was claimed for it. The exploring coil consisted of 500 turns wound 24" by 48", a lot of wire even with no shortage! However, it was required at that time.

After making all connections a friend and I tried out the gadget. For hours we strained at the phones but were able to hear only a constant, weak buzz. Finally there was nothing to do but give up in disgust, with a very low opinion of locators in general and this one in particular. We tried again a few times on other occasions and finally hid the whole locator where it would be out of sight and mind.

About a year later there arose an occasion when I suddenly required some length of wire for some experiment (not in connection with locators) but found that I had none on hand. I then remembered the exploring coil with its mile of wire. I started to unwind the loop and couldn't help feeling that the locator had come in handy after all. What a break! What? A break? Sure enough, about half way down the coil the wire had parted in such a way as to remain unnoticed! This episode may partly account for the fact that I am now known as quite expert in the use of all methods of continuity testing.

To get back to proper construction, the best locators I have ever built were the ones described by Mr. G. M. Bettis in the Feb. 1940 *Radio & Television*, and in the April, 1943 *Radio-Craft*. A number of other excellent circuits are outlined at the conclusion of this article. These are sensitive circuits and will give practical results.

A short while ago I finished building a very compact treasure-finder which for a small-size job is unusually sensitive for metal detection. Really good results have been obtained with it. The schematic is

shown and the photo gives an idea of physical size. Incidentally, there is plenty of room in the cabinet, which was used because it happened to be available for such use.

The 3A8-GT requires only .1 amps at 1.4 volts when its filaments are wired in parallel as it is in this case. The total drain on the "B" battery is less than a milliamperere, so that the drain on the pocketbook is also small. There is room for improvement in this circuit so I am passing it along to you experimenters. I believe it would make an easy outfit for the beginners in this field to start with. The circuit is self-explanatory.

I have now started to experiment with an even more compact treasure device which will use two or three tubes and which, I hope, will be the utmost in sensitivity. It requires but 45 volts of "B" battery. Possibly I may have the circuit and details as

TELEVISION FOR POST-WAR ADVERTISING

TELEVISION is one of the big answers to the post-war question of jobs and a higher level of prosperity, declared Thomas F. Joyce of the Radio Corporation of America at a large meeting of sales executives in New York.

"America's almost limitless production capacity has been convincingly demonstrated during the war," said Mr. Joyce. "The principal post-war economic problem is one of distribution."

Making the point that if people are to be kept at work making goods or growing farm products, those goods must be sold, the power of television as an advertising medium, its persuasiveness in making people want the goods displayed more than the money in their possession, was convincingly demonstrated.

The demonstrations took the form of a comparison of the impact of an ordinary radio and a television "commercial." Several products were first described in spoken "commercial" announcements. Professional actors then presented these sales messages as dramatizations, to give a "preview" of how commercial sponsors might utilize television in the future.

In one of these comparisons, the announcer spoke briefly on the quality of shatter-proof glass. A moment later when this announcement was brought to life, a

large sheet of shatterproof glass was brought on stage, and a brawny man pounded it with a sledge hammer.

Other commercials featured a vacuum cleaner picking up dirt and dust; six men in a tug-of-war disastrously involving a pair of "no rip" overalls; and a thirsty man drinking a glass of foamy beer, complete with lip smacking and smile of satisfaction.

The applause which greeted each television "announcement" showed plainly the greater impact of the sight-and-sound advertisement.

Television, Mr. Joyce pointed out, not only combines sight and sound, but adds "the all-important factor of spontaneity and immediacy; it is capable of taking its audience to a scene of instantaneous action."

Advantages of eye-and-ear broadcasting for department-store advertising, whose present radio budget measured only five per cent of what stores spent, were elaborated by the RCA official.

"Because television has the power to create consumer buying of goods and services beyond anything that we have heretofore known," Joyce said, "we can count upon its helping to bring about a high level of post-war prosperity in agricultural, industrial and the distributive industries, as well as personal and professional services."

well as results available for RADIO-CRAFT readers in the near future.

In conclusion let me state as a veteran in this field that exploring for metal is fun and can be PROFITABLE, too. Here's luck to you!

Bibliography

RADIO NEWS, Sept., 1932—May, 1933.
RADIO-CRAFT, *June, 1931—*July, 1933—*Aug., 1934—*Aug., 1935—*Aug., 1936—Oct., 1935—*Sept., 1939—Dec., 1940—April, 1943.

SHORT WAVE RADIO, May, 1937.
RADIO & TELEVISION, Mar., 1939—Mar., 1941.
POPULAR MECHANICS, Oct., Nov., 1937.
SCIENCE & MECHANICS, Feb., 1939.
RADIO WORLD, Jan., 1938.

*(These back issues of *Radio-Craft* are no longer available at this office, but are noted here to assist those who may be able to refer to them in the files of a library or among their own old copies.—Editor.)

World-Wide Station List

Edited by ELMER R. FULLER

SEVERAL new stations are being heard as the summer season descends upon us. Among them is EPA, located at Teheran, Iran, and run under the supervision and control of the Allied Forces. It operates on a frequency of 16,000 megacycles and is heard on Sundays at 4:12 pm. They may be on the air at other times, but this is the only one reported to us.

CR7BH, Marquis, Mozambique, is being heard on 11.718 megacycles, but we do not have a schedule of their transmissions. We would greatly appreciate reports on reception of this station. XGRS in Shanghai, China, is now using a frequency of 11.69 megacycles and is on the air daily from 11:15 am to 12:30 pm. Reception is not

very good from this station in the eastern part of the United States; it is heard very well on the Pacific coast, and west of the Rockies.

We must have call letters, operating frequencies, and schedule of broadcasts or times heard, on all stations reported to us. Please be sure to make your reports as complete as possible. In this way they will be of much higher value.

A report has reached us that KZRH, Manila, Philippine Islands, is now being operated by the Japanese on a frequency of 9.630 megacycles. Is anyone else hearing this transmitter? Reports would be greatly appreciated. We would also like information on HRN, British Honduras, which has

been heard on 7.875 megacycles recently.

What do you think of the idea of issuing Listening Post Certificates as was done before for the ham bands? Several of our readers have asked about this. Let's hear from you in regard to this matter. The ones issued in the past were printed in two colors and were suited to an 8" x 10" frame.

Several have asked where they can obtain a list of the short wave police and fire stations. At the present time such a list is not obtainable. For this reason, we will list now and then those which are reported to us. If you have heard any, send us the call letters, location, frequency, and whether they are police or fire. They will be compiled as soon as possible.

Mc.	Call	Location and Schedule	Mc.	Call	Location and Schedule	Mc.	Call	Location and Schedule
1.658	WKVC	FISHVILLE POLICE	9.530	WGEO	SCHENECTADY, NEW YORK; East South American beam, 5:30 pm to midnight; European beam, 3:15 to 5:15 pm.	9.635	XGOY	CHUNGKING, CHINA; East Asia, South Seas, North America, and Europe, 7:35 am to 12:30 pm.
2.425	WSYC	7 FIRE	9.535	—	UNITED NATIONS RADIO—ALGIERS.	9.64	LRI	BUENOS AIRES, ARGENTINA; "Radio Belgrano" evenings.
2.480	WPDP	PHILADELPHIA, PA. POLICE	9.535	SBU	STOCKHOLM, SWEDEN.	9.64	KZRH	MANILA, PHILIPPINE ISLANDS.
2.490	WPGS	7 POLICE	9.535	HER4	BERN, SWITZERLAND; North American beam, 7:30 to 9 pm; 9:30 to 11 pm.	9.640	CXAB	MONTEVIDEO, URUGUAY; 5 pm to midnight; to 1 am on Sundays.
2.770	WWMS	ST. ALBANS, VT. POLICE	9.535	JZI	TOKYO, JAPAN; 11:15 am to 2 pm.	9.64	CMZ	HAVANA, CUBA; heard afternoons.
2.770	WWMP	ROUSES POINT, N. Y. POLICE	9.54	VLG2	MELBOURNE, AUSTRALIA; early am till 8:30 am.	9.645	LLH	OSLO, NORWAY; unreported for several months.
2.770	WWMO	OGDENSBURG, N. Y. POLICE	9.54	AFHQ	ALLIED NATIONS RADIO—ALGIERS.	9.645	JLT2	TOKYO, JAPAN; noon to 2 pm.
3.600	—	SS GEORGE VII; heard about noon.	9.54	MTCY	HSINGKING, MANCHUKUO; 9 to 11 am.	9.650	WOOC	NEW YORK CITY; European beam, 5:15 to 7 pm.
3.600	—	SS ELIZABETH NEAL; heard about noon.	9.543	XEFT	VERA CRUZ, MEXICO; 11 am to 2 am.	9.650	DJW	BERLIN, GERMANY; evenings.
4.780	HUB	SAN SALVADOR, EL SALVADOR; heard at 8:45 pm.	9.550	—	"RADIO SHONAN," SINGAPORE; heard at 7:25 to 7:30 am.	9.660	VUD6	DELHI, INDIA.
4.785	HJAB	BARRANQUILLA, COLOMBIA; heard at 8:30 pm.	9.555	XETT	MEXICO CITY, MEXICO; 10 am to 2 am.	9.660	VLQ3	BRISBANE, AUSTRALIA; no recent schedule.
4.830	YY2RN	CARACAS, VENEZUELA; heard at 8:30 pm.	9.562	OAX4T	LIMA, PERU; 7 to 10 am.	9.660	LRX	BUENOS AIRES, ARGENTINA; "Radio El Mundo"; 5 pm to midnight.
4.100	KROJ	LOS ANGELES, CALIF.; Alaska beam, 11:30 pm to 3:45 am.	9.565	JRAK	MOSCOW, USSR.	9.660	HVJ	VATICAN CITY; no recent schedule.
6.110	GSL	LONDON, ENGLAND; North American beam from 8 pm to 12:45 am.	9.565	—	PARAO, PALAU GROUP; 7 to 9:30 pm.	9.665	XGOI	SHANGHAI, CHINA; operated by Japanese, 8 to 9 am.
7.200	—	STATION DEBUNK	9.57	KWIX	SAN FRANCISCO, CALIF.; 8 pm to 12:45 am, daily, South American beam; Oriental beam, 8 to 11 am.	9.665	VLW4	PERTH, AUSTRALIA; 8:15 to 9:55 pm.
7.210	—	BERN, SWITZERLAND; 9:30 to 11 pm except Saturdays.	9.570	WRUW	BOSTON, MASS.; European beam, 5 to 6 pm.	9.665	—	ITALIAN UNDERCOVER STATION; not heard for several weeks.
7.875	HRN	BRITISH HONDURAS.	9.580	GSG	LONDON, ENGLAND; North American beam, 5:15 pm to 12:45 am.	9.670	WRCA	NEW YORK CITY; Brazilian beam, 8 to 11:30 pm.
8.530	YUC6	CALCUTTA, INDIA.	9.58	VLG	MELBOURNE, AUSTRALIA; 11 to 11:45 am.	9.670	WNBI	NEW YORK CITY; European beam, 4 to 7:30 am; 3:45 to 5:15 pm.
9.03	COBZ	HAVANA, CUBA; 9 am to 12:18 am.	9.59	—	TOKYO, JAPAN; heard 9:20 to 9:30 am.	9.675	DJX	BERLIN, GERMANY.
9.125	HAT4	BUDAPEST, HUNGARY; 2 to 6 pm; 9 to 11 pm.	9.59	WLW0	CINCINNATI, OHIO; West South American beam, 7 pm to midnight.	9.675	JVW2	TOKYO, JAPAN 5 to 8 am; 10 am to 12:15 pm.
9.130	HI2G	CIUDAD TRUJILLO, DOMINICAN REPUBLIC; early evenings.	9.590	WCRC	NEW YORK CITY; European beam, 4 to 6:45 am.	9.680	XEQQ	MEXICO CITY, MEXICO; 10 am to 2:45 am.
9.165	—	BERN, SWITZERLAND; heard at 10 pm.	9.595	—	ATHLONE, IRELAND; late afternoons.	9.68	VLW6	PERTH, AUSTRALIA; 9:40 to 10:40 am.
9.185	COCQ	HAVANA, CUBA; afternoons.	9.600	—	ROME, ITALY; heard at 4 pm.	9.685	TGWA	GUATEMALA CITY, GUATEMALA; 9:55 pm to 12:45 am daily.
9.250	COBQ	HAVANA, CUBA; 4 to 7 pm.	9.600	GRY	LONDON, ENGLAND.	9.690	GRX	LONDON, ENGLAND; North American beam, 5:15 to 8 pm.
9.255	—	BUCHAREST, ROUMANIA; 4 to 5 pm.	9.600	CE960	SANTIAGO, CHILE; 8 pm to midnight.	9.69	LRAI	BUENOS AIRES, ARGENTINA; Fridays only, 5 to 5:30 pm.
9.26	GSU	LONDON, ENGLAND.	9.607	HPJ	PANAMA CITY; PANAMA; evenings.	9.693	JIE2	TAIHOKU, FORMOSA; 8:30 to 10 am.
9.290	HI2G	CIUDAD TRUJILLO, DOMINICAN REPUBLIC.	9.608	ZRL	CAPE TOWN, SOUTH AFRICA; 11 to 11:45 am.	9.700	FIQA	TANANARIVE, MADAGASCAR; noon to 1 pm.
9.295	COCX	HAVANA, CUBA; daytimes.	9.610	DXB	BERLIN, GERMANY.	9.700	WRUA	BOSTON, MASS.; North African beam, 4:45 to 6 pm.
9.35	COBC	HAVANA, CUBA; 9 am to 1:15 am.	9.610	ZYC8	RIO DE JANEIRO, BRAZIL; 6 to 11 pm.	9.700	WRUS	BOSTON, MASS.; Mexican beam, 7:30 pm to 2 am; North African beam, 6 to 7:30 am; 4:45 to 6 pm; 6:15 to 7:15 pm.
9.437	COCH	HAVANA, CUBA; 7 am to 1 am.	9.615	XERQ	MEXICO CITY, MEXICO; 10 am to midnight.	9.705	—	FORT DE FRANCE, MARTINIQUE; 5 to 8:30 pm.
9.455	GRU	LONDON, ENGLAND.	9.615	TIPG	SAN JOSE, COSTA RICA; heard evenings.	9.715	OAX4K	LIMA, PERU; 7 to 9 pm.
9.465	TAP	ANKARA, TURKEY; 2 to 3:45 pm; 3:50 to 4 pm.	9.620	—	ADDIS ABABA, ETHIOPIA; 11:30 am to 12:15 pm.	9.720	XGOA	CHUNGKING, CHINA; 8 to 11 am.
9.470	CR7RA	LOUANGA, ANGOLA; 7:30 to 8:45 am; 3:30 to 5 pm.	9.62	—	VICHY, FRANCE; North American beam, evening.	9.720	—	"RADIO PATRIE"; also known as "RADIO RESISTANCE"; unreported for several months.
9.480	CP38	LA PAZ, BOLIVIA; 7 to 11 pm.	9.630	2RO3	ROME, ITALY; off air at present.	9.720	PRL7	RIO DE JANEIRO, BRAZIL; "Radio Nacional" 4:10 to 9:50 pm.
9.485	—	"SLOVAK FREEDOM STATION"; Saturdays, 4:30 to 4:42 pm.				9.724	CSW	LISBON, PORTUGAL; last heard in afternoons.
9.490	KRCA	SAN FRANCISCO, CALIF.; Oriental beam, 1 am to 1 pm.						
9.490	WCBX	NEW YORK CITY; Latin America beam, 5 to 11:30 pm.						
9.495	OIX2	HELSINKI, FINLAND; 4 to 5 pm.						
9.50	XEWV	MEXICO CITY, MEXICO; 9 am to 3 am.						
9.505	JLG2	TOKYO, JAPAN; North American beam, 11:20 pm to 1:15 am.						
9.510	H58PJ	BANGDOENG, JAVA, NETHERLANDS INDIES.						
9.510	GSP	LONDON, ENGLAND; 2 to 3 pm.						
9.52	DXLI3	PARIS, FRANCE; relays Berlin to North America, 5:30 pm to midnight.						
9.530	WGEA	SCHENECTADY, NEW YORK; European beam, 3:15 to 8 am.						

(Continued on page 629)

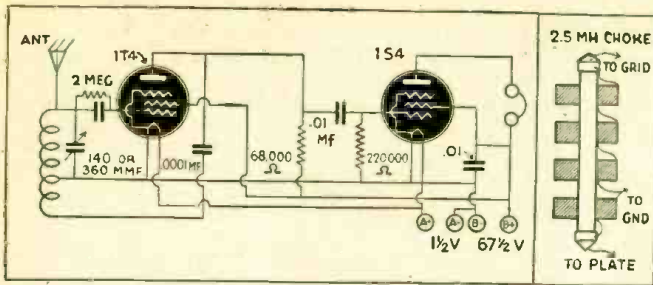

Schematic of the ultra-minute set. An alternate coil is shown right.

"Tom Thumb" Radio

By EDWIN BOHR

THIS radio was designed with the idea of combining maximum gain with minimum size. It has given good volume with an antenna 7 feet long. Most of the parts are such as can be found in old receivers (particularly if you have a discarded portable) or both.

I have used two coils with this set. One is a 2.5 MH choke and the other is an iron core with the coil wound around it. One covers the higher frequencies of the broadcast band—the other the lower. Small coils may be obtained from radio supply houses, but a tickler must be added.

A small amount of regeneration was used, but not enough to necessitate the use of a regeneration control. Regeneration may be increased or diminished by changing the size of the mica condenser between the plate and bottom end of the tuning coil. An .01 condenser was connected across the battery terminals, as there was not room to install it under the chassis.

The panel was made of a piece of bakelite and the chassis from an aluminum coil shield. Phone jacks were made from a section of an ocal wafer socket. They were the smallest thing available that the pins

Photograph and under-chassis view of the ultra-minute receiver. An iron-core coil (just visible behind the right edge of the panel) is used to make the set more compact. The under-chassis wiring compares favorably with that of some larger sets.

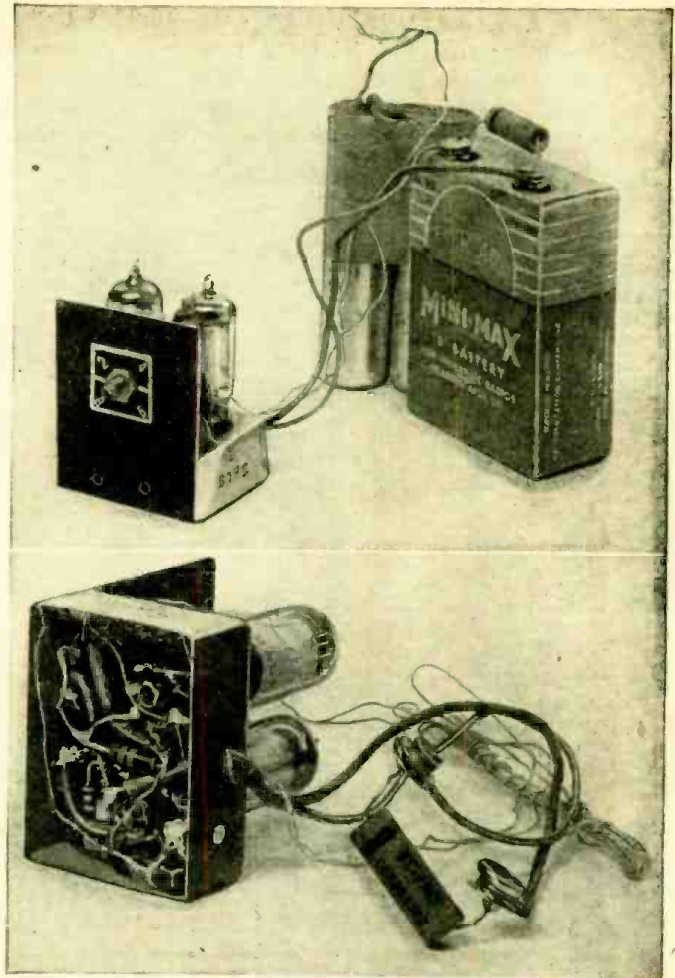

would fit into. The panel is fastened in a very simple way—just stuck on with coil dope.

The whole set is 2 inches long by 2 1/2 inches high (to the top of the tubes, which stick a little above the top of the panel)

and 1 1/2 inch deep. The chassis, under which are mounted all the condensers and resistors with the exception of the .01-mfd. condenser across the batteries, is 5/8 inch high. The circuit is the Hartley, one of the oldest and best.

Radiomen Find Radio Useful, Too!

By EUGENE A. CONKLIN

SINCE radio servicemen have an intimate acquaintanceship with radio *per se* it follows that they might utilize this media to advertise their profession to the public. But for one reason or another, usually boiled down to a basic disinclination to tamper with etherizing, few servicemen have gone in for radio to any appreciable extent.

Matraw Radio, of Watertown; Arthur Selleck, of the same city; Lee Roberts, of Syracuse; and C. E. Reynolds, of Binghamton, New York, do, however, use radio at the moment. Their purpose in "spot-casting" is not to gain more patronage—heaven forbid! Instead, they use it to get across to the public new rules and regulations under which ailing radio sets can be accepted for service.

Matraw keeps his shop closed tightly on Tuesday, Thursday and Saturday. On these three days he tackles the overload of work accumulating on his work bench. He uses spots to implore the public not to call in person or via phone on these "closed shop" days. Matraw schedules his morning "pleas to the public" between 8.00 and 9.00 A.M. The reason is that it's the housewife who calls the shop for instant service, or who plans to bring a set downtown in the family jalopy if she can get gas.

Mrs. Housewife has the radio on for music while she soaks the morning dishes and plans the day's program. Perhaps the radio has been noisy or volume has been fading. She plans to do something about it that very day. She then hears the radio message and puts it off until the next "open shop" day. If her radio has gone dead the chances are she heard the message the day before, or perhaps a few days before the set went west. In any event, she pauses before phoning or paying personal visit to the shop.

Arthur Selleck discourages house calls for the duration via radio. His spots hammer home this clarion call, "No pickups or deliveries unless set is a combination too heavy to bring to the shop." If it's a combination heavy-duty cabinet model Selleck makes an exception. Otherwise, the set must come into the shop under the customer's personal steam. He feels that radio spots between 6.00 and 7.00 P.M. when the entire family may be dining *en masse*, are desirable.

Lee Roberts, of Syracuse, uses radio to request that no electrical items be brought in, because he simply hasn't the time avail-

able for anything save radio repair tasks. Roberts finds that these radiosots save him countless inquiries via phone on that very subject. "We do not service clocks, fans, percolators" is his radio theme song. He too, prefers the 8:00-9:00 spectrum for spot messages.

C. E. Reynolds, of Binghamton, asks via the wireless that his customers do not call in or come in to see if a radio repair job is finished. Instead, he will send a postcard to the customer when his or her set is in playing condition again. This message is repeated again and again via the microphone. He uses noon or 6 P. M. timing for his purposes.

Note that in each case the radio spot has not been used to stir up new business. Spots, as used by these radio service-gentry, are factual messages intended to conserve the serviceman's valuable time. All the servicemen mentioned are in accord on one point.

People pay more attention to what they hear than to what they see in the newspaper. Radio is superior to classified ads or direct mailing for familiarizing the public with new servicing technique. Servicemen should be the first to grasp these facts. So it is hardly surprising that we find them taking advantage of radio's opportunities.

TUBE PRICE CEILINGS

Below are the official OPA wholesale and retail price ceilings on radio tubes. Lower prices than those listed may be charged, of course, but prices above this list are illegal.

IS RADIO FREEDOM ENDANGERED?

FREEDOM OF RADIO is more likely to be endangered through the concentrated control of the industry by powerful economic interests than through too much Government control, declared Clifford J. Durr of the Federal Communications Commission at the fifteenth convention of the Institute for Education by Radio just held.

"This danger to free radio," said Durr, speaking at a panel on the subject "How Free Is Radio," "is far more serious and far more immediate than any threat from the Government."

As for the danger of Federal control, he pointed to the Constitution and the Communications Act to show that such control is not to be expected.

"Speaking as a bureaucrat," he continued, "I would like to point out that there may be restraints upon our freedom other than political restraints. With the concentration of economic power which has been characteristic of our economy, particularly for the past quarter of a century, and which is increasing at a constantly accelerating pace, our actions may be as effectively limited and directed by a system of economic rewards and punishments as by duly enacted laws. Moreover there is no more effective way of distracting attention from these economic restraints than by focusing it on political restraints whether real or imaginary."

"Today we have on the air about 900 dard broadcasting stations—a sufficient number, it would seem, to provide the diversity we have been looking for. With the operators of this number of stations exercising their independent judgment it should be expected that the prejudices, predilections, and mistakes in one direction would be balanced out by those in another, leading, over all, to a fairly balanced presentation of points of view as well as of information and entertainment."

"Thus we have moved from diversification to concentration. We start out with 900 supposedly independent stations: about 600 of these, together, using 95 per cent of the night time broadcasting power of the entire country, bind themselves by contract to four national networks, the four national networks receive 74 per cent of their revenue from four national industries. Maybe this is the road to a free radio, but I doubt it," Durr concluded.

In anticipation of the return of service men from war fronts under the Army's rotation furlough plan, the present nationwide program to further civilian understanding of military security restrictions is being shifted into high gear by the inter-agency Security Committee, the Office of War Information reported recently.

This effort parallels the armed forces' own policy of instructing personnel regarding military information before they return to their homes, according to the Committee which consists of representatives of the Army, Navy, Federal Bureau of Investigation, OWI, and other interested agencies.

The individual citizen's criterion, Committee members emphasize, should be whether he has heard the information over the radio or has read it in newspapers or magazines. If so, it is public property. If not, he should keep still, even though someone else repeated it to him and it seems common knowledge, or harmless and unrelated to the war effort as a whole.

TYPE	MAXIMUM RETAIL PRICE	TYPE	MAXIMUM RETAIL PRICE	TYPE	MAXIMUM RETAIL PRICE	TYPE	MAXIMUM RETAIL PRICE	TYPE	MAXIMUM RETAIL PRICE
00A	\$2.35	5V4G	\$1.60	6K8GT	\$1.30	7E7	\$1.60	32	\$1.30
01A	.85	5W4	1.10	6L5G	1.10	7F7	1.60	32L7GT	1.30
0A4G	1.95	5W4GT	.90	6L6	1.95	7G7/1232	1.95	33	1.30
0Z4	1.60	5K4G	1.10	6L6G	1.60	7H7	1.95	34	1.30
0Z4G	1.60	5Y3C	.70	6L7G	1.60	7J7	1.95	35	1.00
1A4P	1.60	5Y4G	.75	6L7G	1.60	7K7	1.95	35A5	1.30
1A5G	1.60	5Z3	1.10	6N5	1.60	7L7	1.95	35L6GT	1.00
1A5GT	1.10	5Z4	1.30	6N6G	2.35	7N7	1.95	35Z3	1.30
1A6	1.30	6A3	1.95	6N7	1.60	7Q7	1.30	35Z4GT	.80
1A7G	1.60	6A4/LA	1.60	6N7G	1.60	7R7	1.95	35Z5GT	.85
1A7GT	1.30	6A5G	2.85	6P5G	.85	7Y4	1.30	35Z6G	1.30
1B4P	1.30	6A6	1.60	6P5GT	.80	10	2.85	36	1.00
1B5/2S8	1.30	6A7	1.00	6P7G	2.30	12A	1.00	37	.85
1B7GT	1.30	6A8	1.30	6Q7	1.30	12A5	1.00	38	1.10
1C5G	1.60	6A8G	1.00	6Q7G	.90	12A5GT	2.35	39/44	1.00
1C5GT	1.30	6A8GT	1.00	6Q7GT	.90	12A8GT	1.00	40	1.60
1C6	1.30	6A8S/6N5	1.60	6R7	1.60	12B8GT	1.60	41	.85
1C7G	1.30	6A8T/1853	1.95	6R7G	1.10	12C8	1.95	42	.85
1D5GP	1.30	6AC5G	1.30	6R7GT	.90	12F5GT	1.00	43	1.10
1D5GT	1.30	6AC5GT	1.10	6S7	1.60	12J5GT	1.00	45	.80
1D7G	1.60	6A7/1858	2.35	6S7G	1.60	12J7GT	1.10	45Z5GT	1.10
1D8GT	1.95	6AD6G	1.60	6S7GT	1.00	12K7GT	1.00	46	1.10
1E4G	1.30	6AD7G	1.60	6S7GT	1.10	12K8GT	1.30	47	1.10
1E5GP	1.60	6A2SCT	1.30	6S7GT	1.30	12O7GT	1.90	48	1.30
1E7G	2.35	6A2G	1.30	6SD7GT	1.30	12S47	1.00	49	2.85
1F4	1.30	6A2GT	1.30	6S7	1.00	12S47GT	1.30	50	2.35
1F5G	1.30	6A7G	1.60	6S7G	1.00	12S7	1.00	58	1.60
1F6	1.60	6AC7	2.35	6S7	1.30	12S7G	1.30	59	1.95
1F7GH	1.60	6B4G	1.95	6S7G	1.30	12S7GT	1.10	50L6GT	1.10
1G4G	1.30	6B5	1.95	6SH7GT	1.30	12S7GT	1.30	50Z7G	1.30
1G4GT	1.30	6B6G	1.10	6S7	1.10	12S7	1.10	52	2.85
1G5G	1.30	6B7	1.30	6S7GT	1.10	12S7GT	1.10	53	1.60
1G6G	1.60	6B8	1.95	6S7	1.00	12S7	1.00	55	1.10
1G6GT	1.60	6B8G	1.30	6SK7GT	1.10	12S7GT	1.10	56	.80
1H4G	1.00	6C5	1.10	6SL7GT	1.55	12S7GT	1.55	57	.90
1H5G	1.30	6C5G	1.00	6SN7GT	1.30	12S7GT	1.30	58	1.60
1H5GT	1.10	6C5GT	1.00	6S7	1.00	12S7GT	1.00	59	1.60
1H6G	1.30	6C6	1.60	6S7	1.10	12S7GT	1.10	70A7GT	2.35
1H6GT	1.95	6C8G	1.60	6SR7	1.10	12SR7	1.30	70L7GT	1.95
1H6G	1.30	6D6	1.00	6T7G	1.30	12SR7GT	1.30	71A	.90
1LA4	2.35	6D8G	1.60	6U5/6G5	1.30	12Z3	1.00	75	.85
1LA6	2.35	6E5	1.10	6U7GT	1.30	12Z3/12B7	1.95	76	.90
1LB4	2.35	6E5	1.10	6U7GT	1.00	14H7	1.95	77	.90
1LB4	2.35	6F5	1.10	6V6	1.95	15	1.95	78	.90
1LN5	2.35	6F5G	1.10	6V6G	1.30	19	1.30	79	1.60
1N5G	1.60	6F5GT	1.00	6V6GT	1.10	20	2.85	80	.90
1N5GT	1.30	6F6	1.10	6V7G	1.30	22	2.35	81	1.95
1N6G	1.30	6F6G	.90	6W5G	1.95	24A	.90	82	1.30
1P5GT	1.60	6F7	1.60	6W7G	1.60	25A6	1.95	83	1.30
1Q5GT	1.60	6F8G	1.30	6X5	1.30	25A6G	1.10	83V	1.95
1R5	1.60	6G6G	1.30	6X5G	1.10	25A6GT	1.10	84Z4	1.10
1S4	1.60	6H4GT	1.95	6X5GT	1.00	25A7G	1.60	89	1.00
1S5	1.60	6H6	1.10	6Y6G	1.60	25A7GT	1.60	89	2.85
1T4	1.60	6H6G	1.10	6Y7G	1.60	25AC5GT	1.60	V99	2.85
1T5GT	1.60	6H6GT	1.10	6Z7G	1.95	25AC5G	1.60	V99	2.85
1V	1.00	6J5	.90	6Z7G	1.30	25B6G	1.95	117L7GT	2.35
2A3	1.60	6J5G	1.00	744	1.30	25B8GT	1.95	117N7GT	2.35
2A4G	2.35	6J5GT	.90	745	1.30	25C6G	1.95	117Z6GT	1.60
2A5	1.00	6J7	1.30	746	1.30	25L6	1.60	485	1.95
2A6	1.00	6J7G	1.10	747	1.30	25L6G	1.30	950	L.95
2A7	1.10	6J7GT	1.10	748	1.30	25L6GT	1.10	NXD	1.60
2B7	1.30	6J8G	1.60	784	1.30	25Y5	1.60	85	1.60
2E5	1.30	6K5G	1.10	785	1.30	25Z5	1.30	VR90-30	2.35
2V3G	2.85	6K6G	1.30	786	1.30	25Z6	1.30	VR105-30	2.35
2X2-RT9	2.35	6K6GT	1.00	787	1.30	25Z6G	1.00	VR150-30	2.35
3A8GT	2.35	6K7	1.10	788	1.30	25Z6GT	1.00	Majestic	2.35
3Q5GT	1.60	6K7G	1.10	7C5	1.30	26	.75		
3B4	1.60	6K7GT	1.00	7C6	1.30	27	.70		
5T4	1.95	6K8	1.30	7C7	1.30	30	1.00		
5U4G	1.00	6K8G	1.30	7E8	1.30	31	1.00		

Standard Radio Receiver Tubes are guaranteed against defects for a period of ninety (90) days from the date of sale. No extra charge for testing detached radio tubes. Maximum charge of \$0.50 for testing radio tubes which can be removed from the radio without detaching the radio mechanism from the cabinet. Maximum charge of \$1.00 for testing radio tubes if the radio mechanism must be removed from the cabinet to test the tubes. These maximum charges apply to portable or table model radios or phonographs brought to this establishment.

RETAIL CEILING PRICES (For tubes listed in Appendix A)	WHOLESALE CEILING PRICES					
	1	2	3	4	5	6
		Quantities of 1 to 5	Quantities of 6 to 49	Quantities of 50 to 100	Quantities of 101 to 500	Quantities Over 500
70		.41	.37	.35	.33	.31
75		.45	.41	.38	.36	.34
80		.48	.43	.40	.38	.37
85		.51	.46	.43	.41	.39
90		.54	.49	.46	.43	.41
1.00		.60	.54	.51	.48	.46
1.10		.67	.61	.57	.54	.51
1.30		.80	.72	.67	.65	.61
1.60		.99	.90	.83	.80	.76
1.95		1.21	1.10	1.02	.97	.92
2.35		1.46	1.32	1.23	1.17	1.12
2.85		1.78	1.61	1.50	1.43	1.36

The above prices include manufacturers Federal excise taxes. Lower prices may be charged.

**"NO! HOGARTH ISN'T GOING NATIVE—HE'S JUST
SHOWING OFF HIS ECHOPHONE EC-1"**



ECHOPHONE MODEL EC-1

(Illustrated) a compact communications receiver with every necessary feature for good reception. Covers from 550 kc. to 30 mc. on 3 bands. Electrical bondspread on all bands. Six tubes. Self-contained speaker. 115-125 volts AC or DC.



ECHOPHONE RADIO CO., 540 N. MICHIGAN AVE., CHICAGO 11, ILLINOIS

PROGRESS IN INVENTION

Conducted by I. QUEEN

SONIC DEPTH INDICATOR

Patent No. 2,346,093

RADIO-CRAFT readers are well acquainted with metal locators for detecting objects beneath the surface of the earth. A recent development patented by William A. Tolson, Westmount, N. J., now makes it easier to measure the distance below the surface of water to some reflecting object. This should prove of great importance for detecting sunken objects, measuring river bottoms, indicating approaching ships during fog and night-time, etc.

Fig. 1 shows a simplification of the instrument schematic. Tube T1 is a self-quenched oscillator, such as is used in super-regenerative receivers. This tube operates a sound projector, S.P., which may be attached to a hull of a vessel. To operate, the switch is thrown to 0. The control tube T2 is normally operated at plate cut-off as is the final stage of the amplifier.

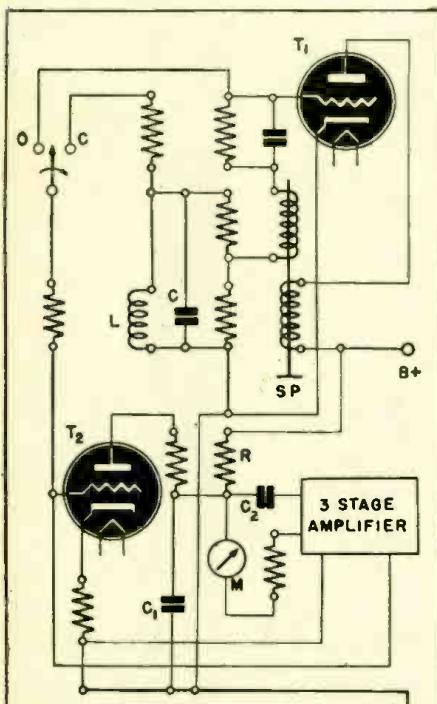

FIG. 1.

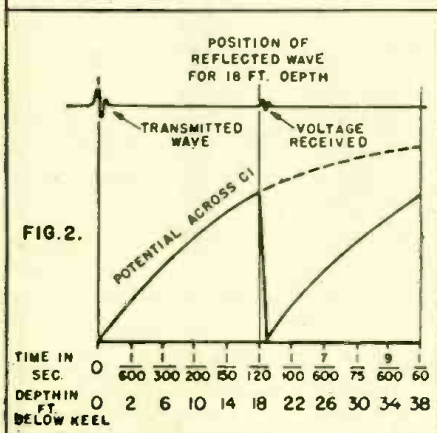

FIG. 2.

Above—A new type of sonic sounder.
Right—Combined sweep and amplifier.

A pulse is generated by the oscillator, actuating the projector and simultaneously unblocking tube T2. Plate current flows through R causing C1 to discharge. It should be evident that while T2 was cut off, C1 was effectively across B plus and therefore fully charged.

At some time later, the reflected pulse returns and actuates the diaphragm of S.P. which is used as both projector and receiver. This reflection is much smaller than the original and insufficient to affect the control tube, but after a three-stage amplification is large enough to unblock the final tube. Current then flows through the meter M (by-passed by C2) thus discharging C1 again.

Evidently the amplitude of current through the meter depends upon the stage of charge of C1 at the moment, and this in turn depends upon the interval of time between projection and reception of the pulse. The meter may therefore be calibrated in units of distance. Fig. 2 shows how the potential across C1 varies. Note that at the instant of arrival of the reflected pulse the voltage drops. For a greater depth than shown, it would have followed the dotted line further before discharge, and vice versa.

Since varying circuit constants might have some effect upon the calibration, the circuit may first be checked for calibration. The switch is thrown to C. Tuned circuit LC has a definite time constant corresponding to some depth and the meter circuit may be adjusted until proper indication is shown.

TELEVISION APPARATUS

Patent No. 2,346,499

THIS invention simplifies the necessary apparatus at the receiving end through the use of a super-regenerative stage. Characteristics of such an amplifier are extremely high sensitivity and broad tuning, so that several radio-frequency stages of amplification may be eliminated.

The signal is applied through a broadly tuned circuit across the control grid and cathode of the super-regenerative amplifier. The tube is self-quenched by means of R and C, which are designed to block at a frequency just under 15,750 cycles per second. The signal is then further amplified and applied to the oscilloscope tube as usual.

The horizontal deflection circuit determines the sweeping of the beam horizontally across the scope tube in saw tooth fashion (lower right corner) that is, it is swept across and then suddenly snapped back to its starting place. This sweeping takes place at 15,750 cps. ordinarily. Since this deflection circuit is coupled to the super-regenerative stage, the two become synchronized.

The signal is enormously amplified due to regenerative feedback while the beam is being swept across the scope tube (A). While being snapped back, (B) however, a high negative potential is applied to the center arm of the potentiometer, effectively blocking the tube. The quenching, therefore, has no effect on the beam seen on the television tube.

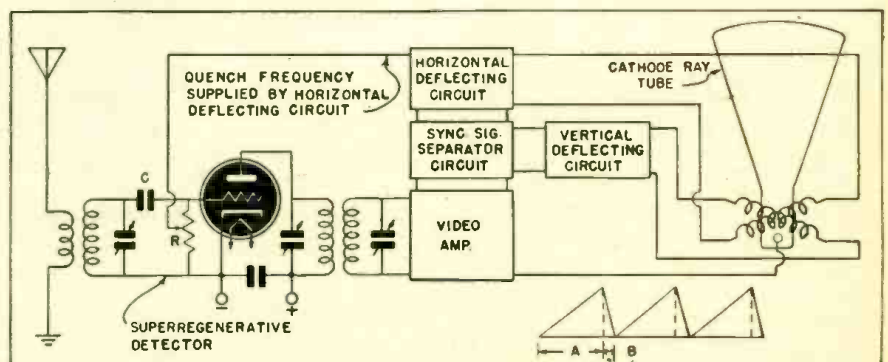

SUPPRESSOR DIODE CIRCUIT

Patent No. 2,346,545

THIS device makes use of a suppressor grid of a pentode together with its cathode as an equivalent diode thus eliminating the necessity of an additional diode plate. This means that an ordinary pentode may be used instead of a diode-pentode in such circuits as detector-amplifiers or voltage indicating circuits.

Fig. 1 shows the schematic of a circuit used as reflex arrangement, whereby the tube is used for three types of operation, R.F. amplification, detection and A.F. amplification.

The incoming signal is fed to the control grid, an amplified voltage being developed across L1C1 the tuned circuit. This voltage is applied through the condensers C to the suppressor grid, where in

(Continued on page 623)

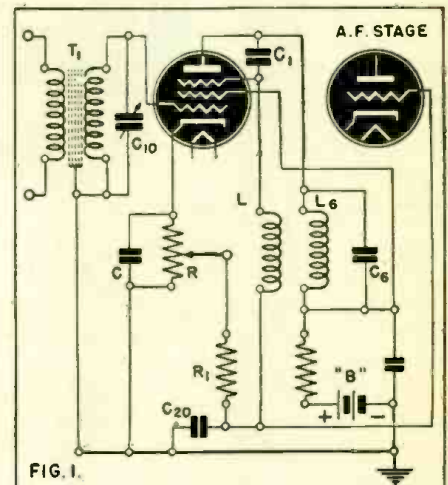

FIG. 1.

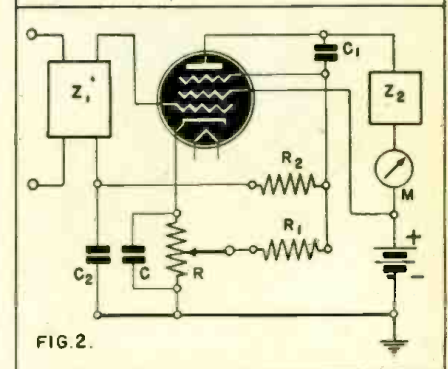

FIG. 2.

Above—A suppressor-diode circuit.

SPRAGUE TRADING POST



A FREE Buy-Exchange-Sell Service for Radio Men

IMPORTANT NOTICE!

We discourage offers to buy or sell anything beyond the O.P.A. ceiling prices, and will not knowingly accept such ads for the Sprague Trading Post.

WANTED—Veteran of World War II needs good used test eqpt. for new business, also tubes such as 6BK7, 50L6, 12BK7, 35Z5, etc. R. Nichols, Box 331, Portland, Texas.

WANTED—Sig. generator, tube tester, V-O-M, or only analyzer combination. P. M. Gardner, 412 E. Ave., Coronado, Calif.

FOR SALE—Various communication receivers. Send for list. Gerald Samoksky, 527 Bedford Ave., Brooklyn, N. Y.

WANTED—Sprague de luxe Telehmike; RCA Jr. Voltohmyst, or any high-grade V-O-M. Cash. Vincent Machek, Jr., Depue, Illinois.

WANTED—Any make electronic voltmeter, ohmmeter, or multimeter in A-1 condition. J. Arleth, 220 Morse St., Camden, N. J.

FOR SALE OR TRADE—Gernsback radio manuals 1-5 incl., ditto auto radio manuals 1-2; Meissner de luxe noise silencer, 3000 ft. test books, parts & tubes. Send for list. Want radio receiver, slide rule or 16 mm. movie camera. W. R. Whitcomb, RT1/c, 1270 Seventh St., Monterey, Calif.

WANTED—Cash for good make tube tester in good condition. Robert Smith, Box 1, Williams, Iowa.

WANTED—Supreme tube & set tester, also sig. generator in good condition. Paul Bernhard, R.F.D. No. 2, Lorain, Ohio.

FOR SALE—200 ft. No. 18 duplex stranded copper wire, \$7.50 f.o.b. Carl O. Williams, R.R. No. 1, Arkos, Ind.

WANTED—Overhead drive recording mechanism for 12" turntable, with crystal or magnetic cutting head. C. W. Wilson, P. O. Box 665, Hopewell, Va.

FOR SALE—Shure 55-CV Uni-dyne mike, new, in original carton. R. W. Harwood, Crescent City, Ill.

TUBES FOR SALE OR TRADE—I have surplus of about 1000 good tubes (many hard-to-get numbers) to sell or trade for late test eqpt. Send for list. Roxy Radio Repair, Mitchell, S. D.

FOR SALE—Noise-reducing aerial transformers, both RCA and Philco, New, in orig. cartons, \$2.75 per pair; with 40' trans. line, \$3.75. Clark Ross, Box 211, Osdan, Utah.

WILL SWAP—Have Hallcrafters Super Sky Rider No. 8X16 in good cond. complete with tubes, crystal and 12" speaker. Will trade this for RCA Rider channelset. John F. Prajko, 1948 Sparks St., Philadelphia, Pennsylvania.

FOR SALE—No. 605 new electro voice dynamic mike with baffle, chrome finish, \$15; Pioneer converter 32v d-c to 110v a-c at 100-watts with extended shaft for aux. drive, built-in filter, A-1 condition, \$25; 2-HV512 emitting tubes in orig. sealed cartons, \$9 for both. York Electric Co., Box 373, York, Nebr.

WANTED—Direct gear-driven phonograph with 10" turntable and one crystal pickup; also 0-1 ma. d-c milliammeter, precision type. Edwin Conrad, 900 Gay Bldg., Madison 3, Wis.

FOR SALE—1938 Hallcrafters Super Sky Rider, 11-tube, 60,000 kc. to 550 kc. with 5,000 ohm speaker in metal cabinet, \$200 on c.o.d. shipment. A real set. C. A. Hammond, 318 S. John St., Table Grove, Illinois.

WANTED—RCA channelset or similar sig. tracing instrument in A-1 condition. Philip P. Goldstein, 288 Ave. P, Brooklyn 4, N. Y.

WANTED FOR CASH—Jackson No. 640 sig. generator, also good tested tubes. Have No. 430 tube tester to sell or swap. Robt. M. Martin, 2844 La Vlore St., Jacksonville, Fla.

URGENTLY NEEDED—All-wave sig. generator in A-1 condition. Also interested in other service instruments. What have you? All letters answered. Geo. H. Apar, 106 Carden St., Endicott, N. Y.

WILL TRADE—I have a Weston No. 772, 20,000 ohms per volt analyzer compl. with test leads and analyzer block and adapters; also a Clough-Brenkle sig. generator, 1937 model, like new. Would like to trade for SX-24 or SX-25 Hallcrafters comm. receiver with speaker. I. M. E. Reed, Dept. of Comm., Sioux Falls, S. D.

FOR SALE—Supreme 500 comb. multi-meter, condenser, and tube checker. Test all late types except peewee 18's & other banams. Supreme 85 tube tester—can be modernized. Weston 489, 0-7 1/2 and 0-150v d-c voltmeter in self-contained case. All in good condition. John T. Duty, 140 Union St., Auburn, Maine.

TUBES WANTED—One to five each. 12SA7, 12SK7, 12SQ7, 35Z5, 50L6, 25Z5, also test eqpt. Cash. Art's Radio Service, 1709 E. Maine St., Enid, Okla.

WANTED—Vibroplex, semi-automatic bug in chrome finish, preferably made later than 1930. Donald E. Brane, U. S. Tombcat, Tusumel, U. S. Engineer Office, P. O. Box 1078, Paducah, Ky.

FOR SALE—Rider's manuals 1-2-3-4-5; Majestic phono motor 33/78 r.p.m. 2-speed, 10" table; Jewell No. 135 0-100 ma.; ditto No. 135A 0-5 volts d-c; Weston No. 500 0-1 d-c; ditto No. 476 0-25v a-c; Leadrite d-c voltmeter double scale 0-60-300; 2 transceiver cabinets; meter case; Upco M-1 lightweight magnetic pickup, 10,000 ohms imp. at 1000 cycles. Write for list. John Arendt, 1722 Melville St., Bronx, New York.

WANTED—Sky Buddy receiver, any type ohmmeter, meters of any type, vibroplex. Cash. Eric Palmer, Jr., 558 2nd St., Brooklyn 15, N. Y.

WILL SWAP—0-1 milliammeter, Rider manuals, all kinds of tubes & other radio products for good slide rule. Also want old watches & jewelry. Robt. G. Browning, 552 11th Ave., Prospect Park, Pa.

WANTED FOR CASH—Will pay highest cash price for 8-29, 8-20R, 8-10H, EC-2, EC-4 or similar small-size communications receiver. Urgently needed. Describe fully. 1st. Lieutenant Shih Yu-Tien, 138A, Hq. Sq., A.A.F.T.S., Scott Field, Illinois.

FOR SALE—Supreme 45 tube tester with charts. Has built-on section for local & aerial tubes, not yet wired. A-1 condition, \$23. Also offer power pack from Eveready radio, and 9" speaker from ditto. Lloyd Johnson, 4314 Nicollet Ave. So., Minneapolis 9, Minn.

WILL TRADE—Hallcrafters S-20R like new on any of following: Channelset; Cornell-Dubilier cap. analyzer; tube checker to handle late tubes; and a good sig. generator. Jos. M. Winchester, 1414 1/2 So. Elm St., Alhambra, Calif.

WANTED—Two wood or metal horns, projectors for 12" speakers, and latest IIRC resistor indicator, also 5" or 5 1/2" or 7" meter, 1000 ohms sensitivity or better. O. K. Radio, 715 South 6th St., Grants Pass, Ore.

FOR SALE—Carron inter-office talk-back system, compl. with 2 speakers & housings, amplifier in metal case, new tubes, and 75' wire. Never used, \$14. Also 1PT-85-100 mixer kit, 5 bands phone & CW compl. with tubes and meter, all new. Robert Maxwell, 1312 E. Washington Blvd., Fort Wayne, Ind.

URGENTLY NEEDED—12A8GT and 35Z4GT to put soldier's radio back into operating condition. Pte. Augustine D.A., B7844, CO/TC, M.P.O. 302, Battlefield, Ont., Canada.

WANTED—Radio City 456 AC-DC universal troubleshooter. Cash, or will trade tubes. Write for list. C. Wagner, 1619 Ave. M, Fort Madison, Iowa.

FOR SALE by serviceman going into armed forces: Soldering iron, core solder, 35Z5 tubes and many others; also Ghirdard's Troubleshooter's manual, and many other radio books. Write for list. Louis J. Jantosh, 525 State St., Bridgeport, Conn.

WANTED—An unused Trylett tester 1175A to salvage some parts I need. Frank Diaz, 748 Westchester Ave., New York 35, New York.

SWAP OR SELL—Hallcrafters 12-tube 8X comm. receiver in perfect condition, complete with table model speaker. Want test eqpt. or cash. Ben L. Sandberg, 38 Washington Village, Ashbury Park, N. J.

FOR SALE—Vol. 1-V abridged Rider's manual, like new, \$16. Solar QC condenser checker, \$10; foundation meter from Superior Inst. pocket lab. No. 1200, 5000-ohm-per-volt, \$7. Matthews Radio Service, 1106 Decker St., Monongahela, Penna.

WANTED—Test eqpt., meters, & tubes. Send full details. Radio Service Shop, Box 1053, Healdton, Okla.

WANTED—Radio test eqpt., also radio parts from one tube to compl. radio shop, but no junk. Send details. Home Radio Service, Battleground, Wash.

"NOT A FAILURE IN A MILLION"

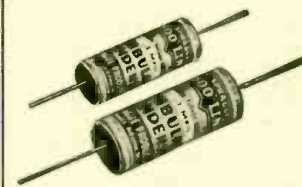

SPRAGUE "TC" TUBULARS

When there's a by-pass capacitor job to do, do it with famous Sprague TC Tubulars—and forget it. They will not let you down! We'll appreciate it if you ask for them by name.

FOR SALE—National AGSX rack panel comm. receiver with tubes & crystal. No speaker or rack. National CRP coil rack panel for 12 coils. GIBSPU rack panel power supply for AGSX. Amateur band spread coils for 10, 20, 40, 80, 160 meters. Coils A, B, C, covering 4000 to 20,000 kc. \$10 f.o.b. F. Sherwood Martin, Greene, New York.

WANTED—Two 35L6GT; 2-117Z6GT; 2-117L7 or 117P; 2-50L6. Also want all-wave sig. generator not more than 4 or 5 years old. Harold O. Jacobson, 452 N. 18th St., Niles, Mich.

WANTED—Complete set of Rider's manuals, or individual volumes. I have for sale one Janette Converter with filter, 110 d-c to 110 a-c, 300 watts. F. J. Westerkam, 1706 N. Patterson Park Ave., Baltimore 13, Maryland.

FOR SALE—We have on hand over 500 radios incl. consoles, combinations; portables, midsets, chassis, auto radios, etc. 116 of these in good working order. Balance checked for defects which are marked on labels attached. Write for details. A & P Radio Engineering, 1813 Pitkin Ave., Brooklyn, N. Y.

WANTED—Tube tester and analyzer. B. Saltnson, 42 Deerfield Drive, Manchester, Conn.

YOUR OWN AD RUN FREE!

This is Sprague's special wartime advertising service to help radio men get needed parts and equipment, or dispose of radio materials they do not need. Send your ad today. Write PLAINLY—hold it to 40 words or less. Due to the large number received, ads may be delayed a month or two, but will be published as rapidly as possible. We'll do everything we can to help you—and the fact that thousands of pieces of Radio-Electronic equipment are in operation today as a result of sales or "swaps" made through The Trading Post offer convincing proof of the far-reaching effectiveness of this service. Remember that "Equipment for Sale" ads bring best results. Different Trading Post ads appear monthly in Radio Retailing Today, Radio Service-Dealer, Service, Radio News, and Radio-Craft. Sprague reserves the right to reject ads which do not fit in with the spirit of this service. When buying Capacitors—please ask for Sprague's by name. We'll appreciate it!

HARRY KALKER, Sales Manager.

SPRAGUE PRODUCTS CO., DEPT. RC-74 North Adams, Mass.



SPRAGUE CONDENSERS KOOLOHM RESISTORS

Obviously, Sprague cannot assume any responsibility, or guarantee goods, services, etc., which might be exchanged through the above advertisements

RADIO-CRAFT for JULY, 1944

New Radio-Electronic Devices

ELECTRONIC TIME-DELAY SWITCHES

Richardson-Allen Corp.
New York, N. Y.

TYPE RA-1335-S Electronic Switches, capable of operating from power-supply sources having any specified frequency between 25 and 2,000 cps., provide fixed time delays over a wide range. Units contain a selenium rectifier, two oil-impregnated paper-dielectric capacitors, two vitreous-enamel wire-wound power resistors, two insulated 1/2-watt carbon resistors, two aircraft-type relays and two standard cold-cathode type gaseous tubes (OA4G and VR140-30). All components are moisture-proofed for tropical use. All wiring is glass-insulated ANJ-C-48 No. 18 stranded.

A typical unit meeting A.N. requirements operates within 5 percent of the rated 20-sec. time delay when energized by power supplies turning out between 100 and 135 volts at frequencies between 350 and 450 cps., at temperatures ranging between 40 and 65 deg. C with up to 95 percent relative humidity. Maximum temperature rise on continuous duty from a 25 deg. C ambient is 25 deg. C. The unit withstands 10-g shock-impact or vibration-acceleration tests and will meet 200-hour salt-spray test requirements. Mounting is permissible in any position.

The 400-cycle unit described in the paragraph above is available with 110 or 220-volt single-phase spst 10 amp. double-make-double-break contacts. A standard connection plug or terminal board is furnished, at the option of the purchaser. The unit measures 5 inches high, 5 3/8 inches long and 3 1/4 inches wide. Flange mounting on 5 1/2 by 3 1/2-inch centers is provided. Power required to operate is 10 watts. Weight is 3 1/4 lbs.—Radio-Craft

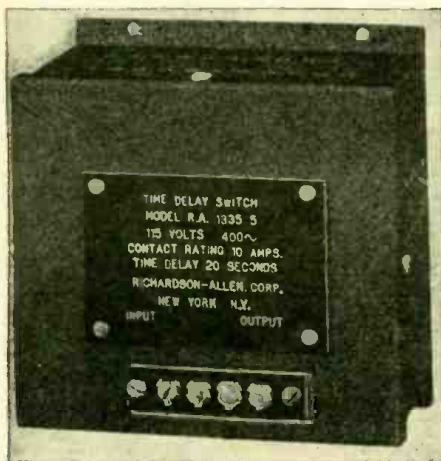

MIDGET REACTOR

Acme Electric and Mfg. Co.
Cuba, N. Y.

THIS reactor, designed for certain electronic applications, compares in size with an ordinary cigarette.

In its aluminum case, it is only one inch in diameter and one and seven-sixteenths inch in height overall. The weight is approximately 2 ounces. Rated at 1.4 henries at .025 amperes direct current, with a resistance value of 100 ohms.—Radio-Craft

PORCELAIN CLAD CAPACITORS

Westinghouse Electric & Mfg. Co.
East Pittsburgh, Penna.

FOR high voltage D.C. applications where space is limited, new solder-sealed porcelain-clad type FPC Inerteen Capacitors are announced by Westinghouse.

From 7,500 volts up to and including the 200,000 volt class, the capacitor elements are hermetically-sealed in a tubular, wet-process porcelain body with solder sealed end closures. The end closures act as the capacitor terminal by connecting the element leads at opposite ends, utilizing the porcelain tube as insulation.



By eliminating the large metal case and bushings required by metal case capacitors, the new porcelain-clad capacitors help maintain minimum over-all dimensions. Larger types are furnished with or without cast mounting flanges. Where castings are used, the capacitors are solder-sealed, then castings are cemented on with mineral-lead compound.—Radio-Craft

RADIO FREQUENCY CAPACITOMETER

General Electric Co.
Schenectady, N. Y.

THE new capacitometer measures directly at radio instead of audio frequency, with measurements being performed with the aid of an oscilloscope instead of earphones. The scale on the unit can be read from 0 to 1000 micromicrofarads when measuring capacitance, with inductance measured in the range of 0 to 1000 microhenries.

The instrument weighs 55 pounds and is a completely self-contained portable unit in a steel case with a hinged cover and handles at the side. Indicating instruments, controls and fuse are conveniently mounted on the instrument panel. The front panel and base are so constructed that they can be withdrawn from the cabinet as a unit for standard rack mounting.—Radio-Craft

BOBBIN-TYPE RESISTORS

Sprague Specialties Co.
North Adams, Mass.

STANDARD resistance tolerance for Koolohm Bobbin-Type Resistors is $\pm 5\%$ for full wattage rating, although closer tolerances, as low as $\pm 1/2\%$, can be provided at lower wattage ratings. Maximum pow-

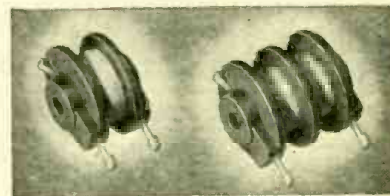

er rating is 2.5 watts and maximum resistance 250,000 ohms in a section 5/8" wide and having a diameter of 13/16". The maximum recommended operating temperature (ambient plus rise) is 150° C.

Koolohm Bobbin-Type Resistors are recommended for use as meter multipliers, as resistance standards in control instruments, as resistance elements of RC oscillators, as power resistors of medium wattage ratings in values to 1/2 megohm, and where a high degree of stability is required.—Radio-Craft.

RESISTANCE BRIDGE

Shallcross Mfg. Co.
Collingdale, Penna.

COMBINING both Kelvin and Wheatstone bridges, the Shallcross Type 638-2 Bridge provides a resistance measurement instrument having range of from 0,0001 ohms to 11.11 megohms in a single, portable unit. The convenience of being able to make practically all resistance measurements with one instrument makes the Type 638-2 unexcelled for laboratory and school use, maintenance work, many forms of production line testing, and field investigations.

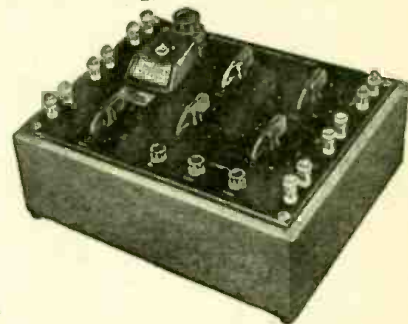

When used as a Wheatstone bridge for measurements between 1 ohm and 1 megohm, normal accuracy is 0.3% or better. Low-resistance measurements using the Kelvin range utilize current and potential terminals to eliminate lead and contact resistance. The accuracy of Kelvin measurements at ranges lower than 0.1 ohm is on the order of 3%. The rheostat is variable in steps of 1 ohm for Wheatstone bridge measurements, and 1 micro-ohm for Kelvin bridge measurements. Separate keys are provided for the battery and galvanometer circuit. Accuracy of component resistors is 0.1% except the 1 ohm resistors which have an accuracy of 0.25%. Built-in galvanometer has a sensitivity of 0.25 microamperes per millimeter deflection.—Radio-Craft

A MESSAGE TO MANUFACTURERS

HE'S ONE OF THE 47,000 MEN . . .

. . . who read **RADIO-CRAFT** this month

Back in the early days of radio, you would find him ceaselessly bent at work in his "basement lab", building his first radio from RADIO-CRAFT. Today, in one of our nation's great war plants, he's the chief engineer applying his storehouse of experience and knowledge to the all-out production of vital communications of war. Men like him—47,000 of 'em—in the army, navy, air-corps, marines and industry read RADIO-CRAFT religiously every month. Your message before these 47,000 men will have a far-reaching influence on the place of your company's products in the post-war future of RADIO-ELECTRONICS!

They are the Radio-Electronic Intelligentsia—those with a highly specialized knowledge of this new field of science and industry.

RADIO-CRAFT

25 West Broadway, New York 7, N. Y.

Read our refreshing, revealing, realistic new booklet "LOOKING AHEAD." It shows the outlook for post-war merchandising of electronics and radio. Sent free on request to manufacturers and wholesalers who write for it on their letterhead (10c a copy to others).

at less than
1¢ PER READER
you can reach
47,000
Radio-Electronics men
with

**RADIO
CRAFT**
AND POPULAR ELECTRONICS

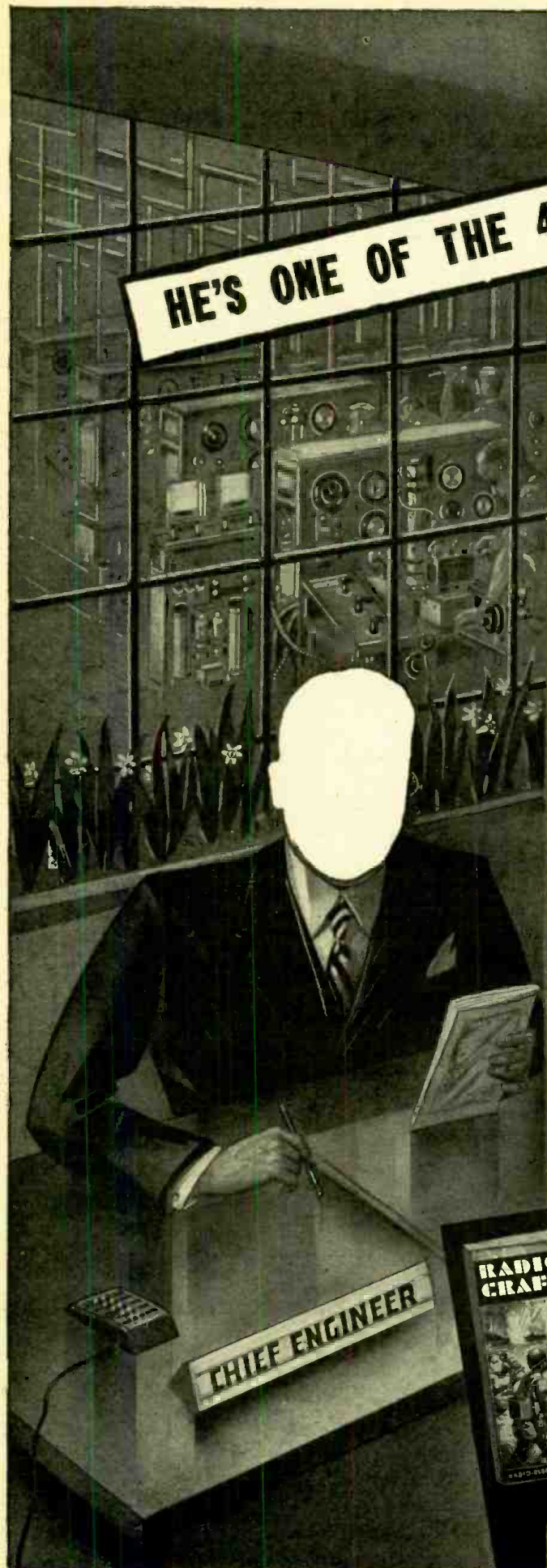

THE QUESTION BOX

VOLTOHMETER

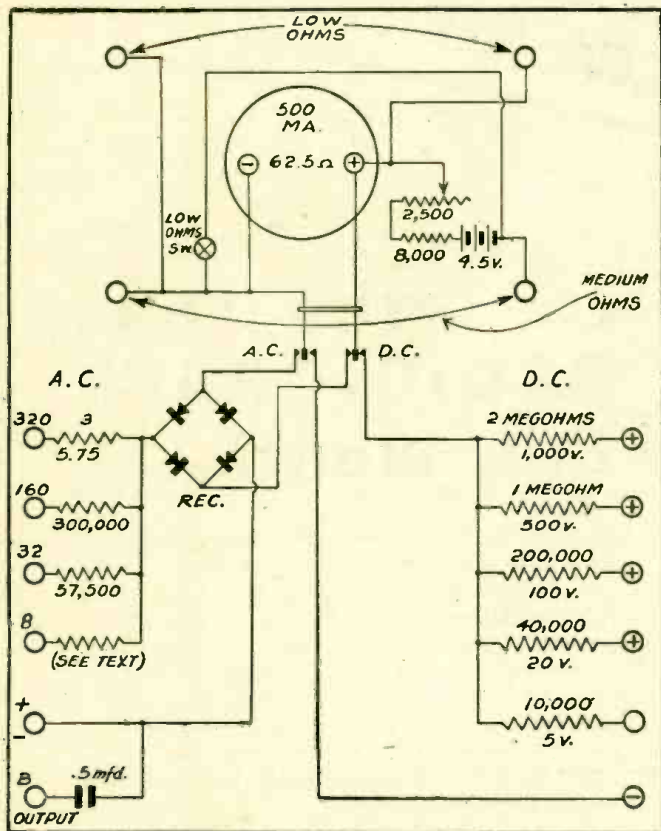

? I would like to have a drawing of a voltohmmeter using a 500 microampere meter I have. Its internal resistance is 62.5 ohms. Voltages required are 5, 20, 100, 500 and 1,000 D.C., and 8, 32, 160 and 320 A.C. I would like to measure from 1 ohm to 10 megohms.—R.J.B., Milwaukee.

A. A 500-microampere movement is an excellent foundation meter for such a tester as you require. The sensitivity is 2,000 ohms per volt, quite sufficient for most radio and electronic applications.

The resistor for the 8-ohm A.C. range will have to be determined by experiment. This is because of the resistance of the rectifier, REC, which may be an ordinary meter rectifier. It will form an appreciable part of the resistance in circuit on the 8-volt scale, which should total 14,400 ohms.

To measure higher resistances than can be handled with the "medium ohms" scale, a 45-volt battery and a 90,000-ohm resistor in series will multiply your "medium ohms" reading by ten.

The output meter is simply an A.C. meter with a condenser of from 0.5 to 1 mfd. in series to block out D.C. One of the test prods is inserted in the jack marked "output" and the other in one of the A.C. jacks, according to the strength of the signal. It is wise to start on a fairly high range and to work at all times on the lower part of the scale.

Charts may be made of the readings for the various ohm scales, as attempts to mark the scale will ruin its appearance.

This diagram may also be used with an ordinary 0-1 milliammeter by halving all resistor values. As there will be no ready-

marked A.C. scale on these, it will be more convenient to have the A.C. readings the same as the D.C. In this case, the resistors will be 9 the value of the corresponding resistors on the D.C. side of the meter.

FOUR-IN-TWO RECEIVER

? Please print a diagram of a receiver using a 6F7 and a 25A7 tube. We want one stage of R.F., detector and one stage

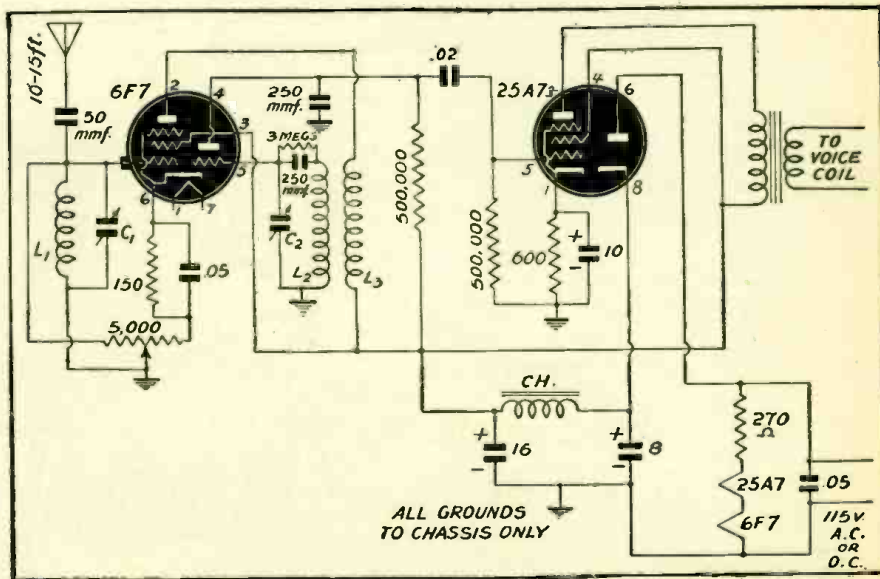

All queries should be accompanied by a fee of 50c to cover research involved. If a schematic or diagram is wanted, please send 75c, to cover circuits up to five tubes; over five tubes, \$1.00.

Send the fullest possible details. Give names and MODEL NUMBERS. Include schematics whenever you have such. Serial numbers of radios are useless as a means of identification.

All letters must be signed and carry FULL ADDRESS. Queries will be answered by mail, and those of general interest reprinted here. Do not use postcards—postmarks often make them illegible.

No picture diagrams can be supplied. Back issues: 1943, 25c each; 1942, 30c each; 1941, 35c each, 1940 and earlier, if in stock, 50c per copy.

EXPANDER-COMPRESSOR PROBLEMS

? The article, "A New and Improved Expander-Compressor," in the 1944 Radio-Electronic Reference Annual has started some argument in our Signal section. What is the score on using the 6SK7 as a triode, and bringing the B-plus to the cathode of the 6SK7 through a 30,000-ohm resistor and to the cathode of the 6SJ7 through a 40,000-ohm resistor? This business of a resistor between plate and cathode has us stumped. Why not hook up the 6SK7 like a normal pentode, and hook both tubes up as in a regular resistance-coupled amplifier, as far as their cathode circuits are concerned?—M.A.S., New York City.

A. We are not sure why the circuit shown uses a 6SK7 triode-connected, instead of the pentode connection or another type of triode. We have seen earlier sets by the same designer which used a similar tube pentode-connected, with control voltage applied to the grid and suppressor, so assume that he must have got the combination of characteristics he wanted in this particular tube and circuit.

The practice of attaching a resistor between high voltage and cathode (you will note that the connection is not to the plate) is old in radio. By having a steady current flowing through this circuit the cathode bias is semi-fixed and is less affected by changes in the current through the tube. The article, "Fixed Bias Amplifiers," last September, discussed this problem.

of straight audio.—B.R., Indianapolis, Ind.

A. The schematic is shown herewith. L1, L2 and L3 are ordinary broadcast coils. The primary of L1 may be ignored, or may be hooked in as the aerial circuit if that gives better results than the capacity coupling shown in the diagram. C1 and C2 should preferably be two independent 350-mmf. variables, though a 2-gang type can be used. CH is a small A.C.-D.C.-type choke.

Use it up . . .

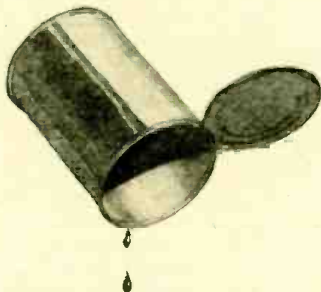

That's the thing to do in wartime. Eat every bite of food, save every scrap of soap, make a patriotic habit of stretching all the supplies in the house so they go further, last longer.

Wear it out . . .



This year old coats, old shoes, are a badge of honor. They show you're sensible enough to know that one way to help win the war, to keep prices down, is to wear your old things out!

Make it do . . .



Before you spend a penny in wartime, ask yourself, "Do I really need this? Or do I have something now that will do?" As you patch and darn and turn, you're keeping prices down.

or do without!



When you put your money in War Bonds, savings, taxes, insurance—you're putting your money to work fighting the war and building a sound, stable nation for the peace to come.

It's **your money** you're saving when you help keep prices down. For it's buying too much when there's too little to buy that sends prices up. And when prices go up—and keep going up—your savings, your future, are in danger.

How can you help keep prices down?

See that prices go no higher . . . Be a saver—not a Buyer!

By never spending a thin dime you could turn into a War Stamp. By thinking twice—and thinking "No"—at every urge to open your purse.

By wearing old things out, making makeshifts do. Remember, it's the things you *don't* buy that keep prices down!

A United States war message prepared by the War Advertising Council; approved by the Office of War Information; and contributed by this magazine in cooperation with the Magazine Publishers of America.



TRY THIS ONE!

A PILOT-LAMP FUSE

I consider it patriotic—not to say economical—to put a .150-ampere pilot lamp in series with the high-voltage center-tap of the transformer in any experimental power packs I use.

With the 10-cent lamp in place, a short at any point in the circuit burns out the bulb and saves the transformer from harmful overload.

WILLIAM H. PORTER,
Los Angeles, Calif.

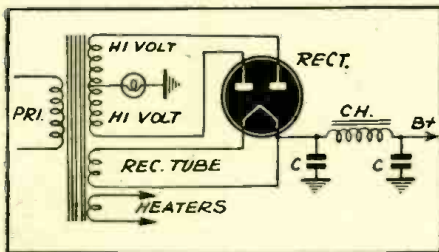

REPAIR FOR LINE-CORD

If a line cord resistor has a break in it (as at X for example) a simple temporary repair can be effected by running a lead from the terminal at which "A" connects to the set, to an ordinary incandescent light socket and then connecting the other terminal of the socket to the terminal at which "B" is connected. Use a lamp in the socket which will have the same resistance (approximately) that the line cord had originally. Special cases may require special combinations of series or parallel arrangements to get the correct resistance.

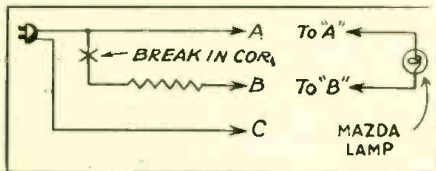

I used a 25-watt, 115-volt Mazda lamp as a temporary repair for an RCA Model 25BP. This is a three-way portable and originally used resistance of 545 ohms for a voltage drop of approximately 79 volts at .15 amps. The resistance of the 25-watt lamp is approximately 530 ohms which is close enough to be used satisfactorily. The lamp can be mounted in any convenient place, preferably exposed to the open air if possible.

HARRY. A. FREIBERGER,
College Station, Texas

WAR-TIME VOLT-OHMMETER

While working in the Enlisted Reserve Corps radio school, we needed a small tester for measuring volts and ohms. The school had plenty of testing apparatus, but when three classes had gathered in the lab for working out the government experiment sheets one would have considerable difficulty running around and borrowing a meter from some fellow-worker.

Standard meters were of course unavailable, so a pair of small Readrite meters (left over from a correspondence course), were used.

Since batteries were as scarce as meters, a

small power supply using a 117Z6-GT half-wave rectifier was built to supply voltage for the ohmmeter. The power supply filter consisted of a 5000-ohm, one-watt resistor and dual 20 Mfd. electrolytic condensers.

One of the meters was a 0-5 Ma. This was adjusted so that it could be brought to a zero reading (full-scale) by means of a variable Bradley-ohm of about 25,000 ohms resistance. This was adjusted with a small pointer knob on top of front panel.

The small ohmmeter will measure only from 2,000 ohms to 1 megohm, though it could be bypassed with a shunt resistor for a lower ohm scale. The scale can be calibrated by using standard fixed resistors and then, if desired, marking with India ink, turning the old scale over or using a new one to mark on. Although the meter is cheap in construction, it worked well for this purpose.

The small voltmeter is a 0-50 D.C. Readrite voltmeter. A 10,000-ohm, 1-watt resistor increased the range to 250 volts.

HOMER L. DAVIDSON,
Fort Dodge, Iowa.

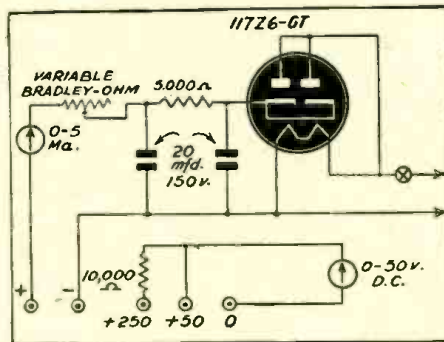

2-VOLT POWER PACK

The transformer on this vibrator pack is an old 2.5-volt filament transformer, with a few turns taken off the 2.5-volt winding to change the turns ratio of the secondary.

We use a 6-volt synchronous vibrator with approximately $\frac{2}{3}$ of the winding removed for operation on 2 volts. It works very well.

Using the smallest parts obtainable, this can be made into a very compact unit.

EUGENE R. GUTCHMAN,
Fl. Benning, Ga.

(The 0.1 condensers may have to be changed for other values, depending on the individual transformer and vibrator used. The correct capacity is that which gives least sparking at the vibrator points and lowest "A" battery current.—Editor)

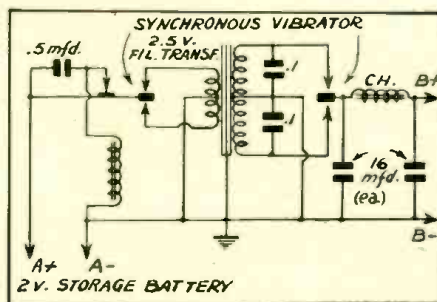

QUICK SET CONVERSION

I have seen several extensive explanations on how to convert an auto radio to house use. There were several conversion circuits in your issue of May, 1943. Some of these called for installing a special power transformer, or even a complete power pack in sets which use a synchronous rectifier. Another plan needed a storage battery charger and supplied the radio with 6 volts D.C., the same as it had from the car battery.

The simplest method used a 115 to 6-volt transformer. Using this system, I converted a set for home use in 20 minutes with only a toy train transformer which was lying around in the junk box.

First I removed the vibrator and inserted a wire jumper to supply 6 volts A.C. to the primary of the set's power transformer. Then I hooked up the 6-volt tap from the train transformer to the regular A lead and shield or ground.

I turned the radio on and it started right up and worked beautifully. There is no hum and it was not necessary to add anything to the filter section. This would not work on a set with a 6-volt dynamic speaker, but my set has a PM.

The radio can be used again on 6 volts D.C. by merely taking out the jumper, putting the vibrator back in and disconnecting the train transformer. Try it!

NORTON E. FAUTZ,
Portland, Oregon

IMPROVING THE CRYSTAL

Some years ago I tried the fixed crystal detector in tubular form put out by the Carborundum Co. of America, and a little later tried their "Adjustable" model, claimed to be permanently sensitive. Success was indifferent, and the crystals were abandoned.

Recently I got out the old carborundum crystals and started a few experiments. The old fixed crystal was supposed to have "five pounds contact pressure." I removed the cap with the adjusting screw, mounted the tube in a vertical position, soldered a light flexible pigtail to the brass side of the chromium-plated brass slug and let the slug rest on the crystal with its own weight only.

I find this to be a great improvement over either the fixed or adjustable types, and use it regularly. I sometimes lift the slug by its pigtail and rotate it a little, or jar the set, to revive sensitivity, but this need only be done at rare intervals.

In short, I find that chromium-on-carborundum, with light pressure, the most satisfactory crystal.

H. R. SMITH,
Elstow, Sask.

QUICK TRANSFORMER CHECK

Connect a 15- or 20-watt 115-volt lamp in series with test leads and the line. If the transformer is good the lamp will light dim on the primary and will not light at all on the high-voltage secondaries. It will light very bright on the filament windings. Also test from each of the windings to the laminations to see that none are grounded. If the transformer is shorted the lamp will light up to full brightness on the primary.

H. G. QUADE,
Houston, Texas

Available Radio-Electronic Literature

Manufacturers' bulletins, catalogs and periodicals.

A NEW SERVICE FOR RADIO-CRAFT READERS: In order to save your time, postage and incidental work in writing a number of letters to different manufacturers to secure the various bulletins offered, proceed as follows:

On your letterhead (do not use postcards) ask us to send you the literature which you designate. *It is only necessary to give us the numbers.* We will then send your request directly to the manufacturers, who in turn will send their bulletins or other literature directly to you.

112—TUBE SUBSTITUTION DIRECTORY, for emergency servicing. Issued by the Radio Corporation of America. A listing of 304 RCA receiving tube types, with (in most cases) one or more tubes which can be used as replacements. The complete list includes more than 2,000 possible substitutions.

Special considerations involved in a given substitution are indicated by a number code, indicating space limitations, filament voltage or current changes, wiring and socket changes.

The RCA Tube Classification Chart which appears in their tube manual is also published in a double-page spread (8 1/4 x 12 inches) which makes for easy reference. Suggestions and calculations for adding series and shunt resistors to a heater string—with diagrams, are included.—Price 10c.

113—CATALOG 128. Radio City Products Co. A 19-page catalog illustrating and describing such of the company's models as are available to regular commercial purchasers with the required priority ratings. Other models not listed are stated to be available for the Armed Forces and contractors to the Government. The instruments listed include Insulation Testers (reading to 10,000 megohms), Limit Bridges, Electronic Voltmeters and a number of electronic and other Multitesters.—Gratis to interested parties.

114—CURRENT-REGULATING COMPENSATOR, for G-E Thyatron-Welding Control. A 4-page bulletin discussing current-variation problems in welding and describing the application of the G-E CR7503-D160 control. Characteristic curves show-

ing small variations in welding current for changes in line voltage, power factor or impedance are included.—Gratis.

115—JFD BELT AND BALLAST BOOK, published by the JFD Manufacturing Co. Brooklyn, N. Y.

A 4 x 6 1/2-inch brochure of 97 pages, describing the applications of the company's belts and ballast tubes. A complete list of modern radios is given, with the JFD belt number suitable for replacement. Another list of all ballasts is given, with the JFD replacement type and instructions on removing pins on the new ballast. This list is lengthy, covering 35 pages.—Price \$1.00.

116—THE INSIDE STORY OF DRY BATTERIES. National Carbon Co. A 48-page booklet on the history, theory, construction and use of dry cells.

A considerable amount of space is given to theoretical considerations, with numbers of figures using water-tank analogies to show increase and decrease of voltage, amperage, cell life cut-off points with different battery connections. The chemical action in the battery, which produces the electricity, is also fully discussed, with several understandable diagrams.

Ten pages are devoted to characteristics of dry cells under practical conditions of use and shelf storage, and a number of pages to illustrations and descriptions of "Eveready" cells of different types, with cut-away views of the internal construction. The same cut-aways appear in numbers throughout the other chapters, and are an excellent feature of the book.—*Gratis.*

UNCLE SAM WANTS YOUR IDEAS

The National Inventors Council of the Department of Commerce in Washington has recently asked for another lot of ideas of potential value to the war effort. Of particular interest to *Radio-Craft* readers are two ideas, the solution of which will not only save many lives but will appreciably shorten the war. The two ideas follow:

(1) **A GAS MASK THROUGH WHICH THE VOICE CAN BE HEARD CLEARLY.** (A lip mike or some other mike will come to mind here, but the trouble is that an amplifier and other radio equipment is needed, while the War Department no doubt requires a purely acoustical device in conjunction with the gas mask.)

(2) **AN OPTICAL METHOD OF DISTINGUISHING BETWEEN NATURAL GREEN AND ARTIFICIAL GREEN.** (Electronic experimenters will be interested in the solution of this problem which most likely can only be solved either by pure photographic methods whereby a special photographic plate can differentiate between artificial and natural green vegetation, or otherwise by electronic means whereby a special photo-electric cell can

make a distinction between the two colors.)

Other ideas wanted include:

A MEANS OF CONTROLLING AN OUTBREAK BY FIRE IN TANKS FOR A SUFFICIENT LENGTH OF TIME TO EVACUATE THE MEN INSIDE THE TANK.

A LIFE-VEST WHICH CAN BE INFLATED AUTOMATICALLY AND TURN AN UNCONSCIOUS MAN ON HIS BACK IN CASE HE IS THROWN OVERBOARD INTO THE WATER.

A DURABLE COATING WHICH COULD BE APPLIED IN THE FIELD TO REDUCE THE GLARE FROM A GLASS SURFACE.

The council, which has sifted some 200,000 ideas since it was formed in 1940, reported that one of the suggestions accepted was an electrical firing device for the "bazooka" rocket weapon.

Another idea accepted was a simple signaling mirror for saving men adrift at sea. Now standard equipment on all lifeboats and rafts, the mirror has two fine crossed lines through which a person can aim a signal at a distant plane.

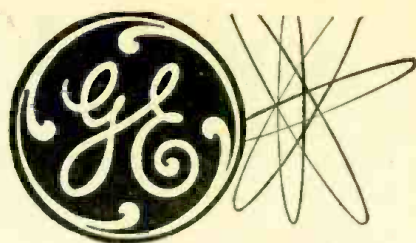

... PORTABLE TUBE CHECKER

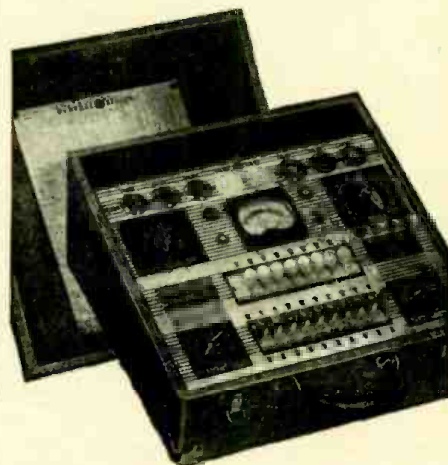

THIS portable G-E Tube Checker contains sockets for all American tube types . . . provides practically a complete service shop of tube analyzing equipment. Equipped with the ingenious PMT Circuit Switch, this instrument is just one in the new General Electric line of SERVICE TESTING EQUIPMENT.

Among the other sturdy G-E units available for testing electronic circuits and component parts are: G-E uni-meters, audio oscillators, oscilloscopes, condenser resistance bridges, signal generators and other utility test instruments. For complete details about these accurate instruments, please fill out the coupon below. . . .

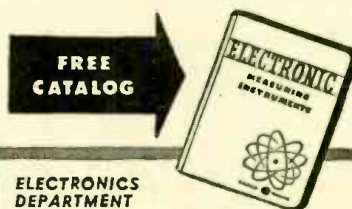

**ELECTRONICS DEPARTMENT
GENERAL ELECTRIC CO.
Schenectady, N. Y.**

Please send, without obligation to me, the General Electric Testing Instrument Catalog, R-7 (loose-leaf), for my information and files.

Name _____
Company _____
Address _____

GENERAL ELECTRIC
Electronic Measuring Instruments

Radio-Electronic Circuits

★ Prize Winners In Relay Contest ★

FIRST PRIZE \$5.00 . . . RICHARD GRAHAM

HONORABLE MENTIONS—1 YEAR SUBSCRIPTION

FRANK RENNER, ROGER MARSH, JOHN G. RICKERT

TWO RELAY CIRCUITS

Here are my ideas for substituting a low resistance relay for the unobtainable high resistance type. The first illustration shows the answer to the problem when A.C. or pulsating D.C. is used and the second shows the hook-up when only D.C. is to be used.

In the first case the primary of a universal output transformer is matched to the for-

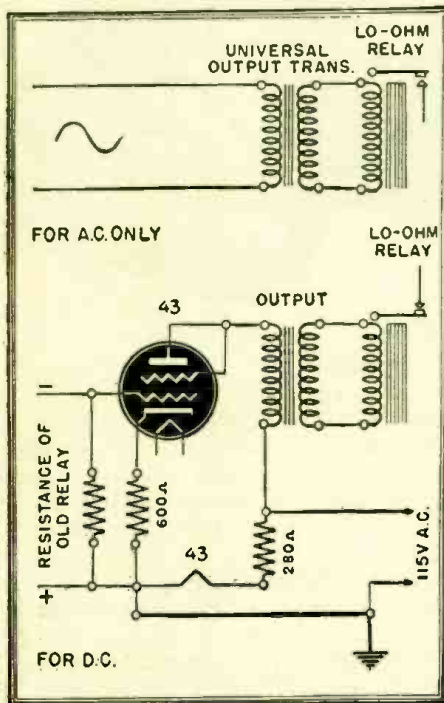

mer relay (high resistance) while the secondary is matched to the low resistance relay, solving the problem.

If the relay is to be used on pure D.C., the problem is a little more complicated. The

A few of the entries will have to be printed in the August issue because of lack of space. The prize winning solutions of Bottleneck No. 2 will be announced in our September issue.

negative side of the relay voltage goes to the grid of the 43. The tube is biased so that current flows until the relay voltage is put on the grid. When this happens, the plate current of the 43 is cut off. As before a matching transformer is used. Line voltage (A.C.) is applied to both plate and filament and is induced in secondary to actuate the relay.

RICHARD GRAHAM
Teaneck, N. J.

(A simple and effective substitution. However, it might be better to bias the 43 to cut-off without excitation and connect the positive end of the incoming voltage to grid. In this way, the low-ohm relay will remain open when there is no incoming voltage across XX. With a D.C. voltage at XX, the relay will close. These conditions are the same that would be obtained were we to actually use a high-resistance relay. It is comparatively easy to obtain relays that will operate on the large plate current of a pentode. Thus in many cases the relay can be inserted directly in the plate circuit, and no matching transformer is needed.—Editor)

A CLEVER "DODGE"

Here is my answer to bottleneck No. 1. I have constructed a high-resistance and sensitive relay from a 12-volt Dodge cut-out.

The original winding was removed and another put on. I used the wire from the secondary winding of an old spark coil. I did not count the turns, it is not necessary. The coil was wound about $\frac{3}{4}$ " thick and the full length of the core.

The above costs nothing to make, takes about an hour to assemble and works per-

fectly. It takes about 1 or 2 Ma of current to close the points. Arm (A) can be bent for less spring-tension.

FRANK RENNER
Nobleford, Alberta, Canada.

FROM AN OLD TRANSFORMER

Any transformer, choke or coil, with the desired resistance plus a suitable pole piece can be used for this relay. I used a push-pull unit.

Stack all the laminations as per the drawing. The armature can be made from any suitable bar or strap iron. I used a piece of sheet steel. For contact points I salvaged the points from discarded vibrators. These I removed from the old unit with a punch, mounted them on the new armature by drilling a hole and then peening the point to the armature. The stationary point can be mounted in any convenient way.

There are several ways to make the pivot. It can be either a knife or bearing type. In my case I found it convenient to use the balance-wheel assembly from an old alarm clock. Part of the clock frame surrounding the pivots was used to mount the armature on the coil. The balance-wheel was removed from the shaft, but the balance-wheel spring was left on to provide some of the tension and also complete the electric circuit, as is done in meters.

The tension spring is hooked on the armature by drilling a small hole. (I used four holes spaced $\frac{1}{8}$ inch apart for different tension adjustments.) The spring should be very light. The adjustment screw is self-explanatory. Use one with a fine thread, and you can get a hairline adjustment. A backstop must also be provided so that the armature cannot move too far away from the coil. This may be threaded and will also act as a sensitivity adjustment.

Measurements have been omitted intentionally, because these will depend on the material available. The coil was also omitted to make the drawing clearer.

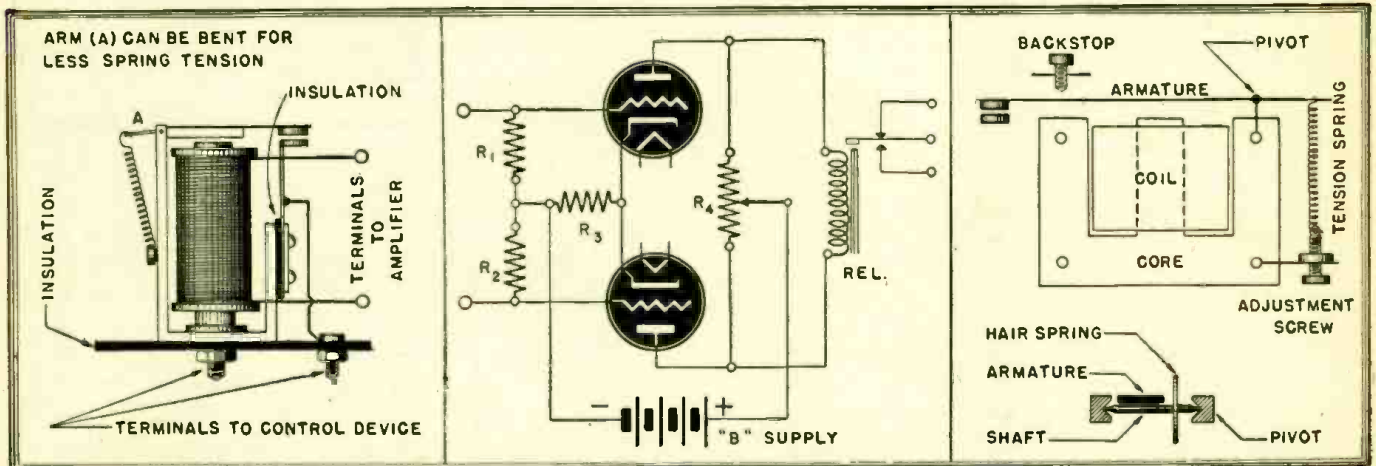

This relay is made from an old Dodge cut-out—A 2-tube relay, described on opposite page—An old transformer supplied material for this.

Incidentally, my relay has two resistances, 1,000 ohms if only half the push-pull winding is used, and about 2,000 ohms if it is all used.

JOHN G. RICKERT
Pittsburgh, Penna.

A 2-TUBE SOLUTION

I have successfully used the following substitution for the high resistance relays which are impossible to obtain. I use a D.C. amplifier of the type shown, using an input resistance of the value desired, and enough current is available in the plate circuit to operate a low resistance relay.

The type of tubes used is not critical, the only requisite being that they draw enough plate current to operate the relay available. R1 and R2 should be equal, their sum being whatever value is required in the circuit where this unit is to be used as a relay substitution. R3, the bias resistor, should be calculated for the tubes being used. R4 can be from 1000 to 50,000 ohms, depending upon tubes and relay used, and should be of high enough wattage to stand the load.

R4 is used to compensate for any unbalance in the tubes, and should be set so the relay is in opened position when there is no input voltage.

ROGER MARSH
El Monte, Calif.

Canada has appointed a Committee on Broadcasting to investigate that country's radio set-up, report on complaints—chiefly by independent broadcasters in competition with the government's Canadian Broadcasting Corporation—and make suggestions for future improvement.

HALLICRAFTERS ★ HALLICRAFTERS



COMPLETE STOCKS

I have in stock NC-200s \$174.50 complete and some Hallicrafters receivers available for immediate delivery on priority and the following parts without priority: meter rectifiers \$1.95, transmitting tubes, transformers, resistors, condensers, panels, chassis, etc. Your orders and inquiries invited.

RECEIVER HEADQUARTERS for the Nation

BEFORE the war Bob Henry served the amateurs as the world's largest distributor of communications receivers.

Now Henry Radio is Hallicrafters receiver headquarters for the Nation at war. Hallicrafter Receivers can be supplied on AA-1 priority. I can usually supply SX-28s at \$179.50, SX-25s at \$94.50, and PM-23 speakers at \$15.00 at once. It takes longer to supply other models.

Soon, it is hoped, non-priority orders can be filled and Bob Henry can become again Hallicrafters headquarters for the nation at peace.

I have stores at Butler, Missouri, and at 2335 Westwood Blvd., Los Angeles 25, Calif.

Your orders and inquiries are invited.

Bob Henry, W9ARA
HENRY RADIO SHOPS

Butler, Mo. and Los Angeles, 25, Calif.

"WORLD'S LARGEST DISTRIBUTOR OF COMMUNICATIONS RECEIVERS"

HALLICRAFTERS ★ HALLICRAFTERS

FIX ANY RADIO

Amazing New Invention

**Simplified
Radio
Servicing
by
Comparison
Method**

Find radio faults with a new simplified method. Repair radios in minutes instead of hours. Revolutionary, different Comparison technique permits you to do expert work almost immediately. Most repairs can be made without test equipment. Simple point-to-point, cross-reference, circuit suggestions locate faults quickly and easily.

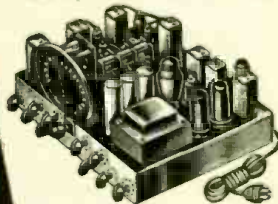

New 1944 Edition

**REPAIR ANY RADIO
IN MINUTES — NO TESTERS NEEDED**

Learn how to locate the source of trouble in any radio without equipment. Make needed tests, measure voltage, trace the signal, by using only a resistor, small condenser, and a crystal detector. Inject signals without any signal generator. Test parts by the new Comparison method. Test tubes without equipment. Repair any radio expertly following illustrated, simplified plans. Improve your radio servicing ability. Examine and apply the plan for 10 days without obligation or risk. Send coupon today.

**COMPLETE
\$1.50
ONLY
SPECIAL OFFER
READ THE DETAILS**

Learn trouble-shooting short-cuts; find any radio fault with ease. Follow the tests shown on 16 large circuit blueprints. Over 1,000 practical repair hints. Hundreds of simplified tests using a 5c resistor and any filter condenser. Introductory material for beginners and to serve as review for experienced radio men. Several chapters on test equipment. Complete plan in manual form, 112 pages, 8½ x 11 inches. Sold on no risk trial. Money-back guarantee.

SUPREME PUBLICATIONS

328 S. Jefferson St. Chicago 6, Illinois

Ship postpaid the new complete Simplified Radio Servicing by COMPARISON Method manual for 10 days' examination. I am enclosing \$1.50, full price. I must be entirely satisfied or you will refund my total remittance.

NAME:

ADDRESS:

KITS

SYLVANIA SERVICEMAN SERVICE

by

FRANK FAX



If you need a good service kit, take a look at these. They are available at low cost because Sylvania orders them in quantity. Send for yours now while it is still in stock.



SERVICE KIT NO. 1 is sturdy in construction, has black leatherette covering, metal fittings, handy tool tray and neat professional appearance. Measures 10 x 17 x 7 inches. Makes service calls easier to handle. Price: \$3. Also Service Kit No. 1A. Same as Kit No. 1 except covered in black and white airplane cloth instead of black leatherette. Price: \$3.



SERVICE KIT NO. 2 has the same quality construction but is roomier. Measures 14 x 22 x 8 inches. Many servicemen put both kits to good use. While they last: \$5.

If your Sylvania distributor does not have service kits in stock, send your order to Frank Fax, Sylvania, Emporium, Pa.

SYLVANIA

ELECTRIC PRODUCTS INC.

RADIO DIVISION

U. S. OWES DEBT TO RADIO "HAMS" (Continued from page 60)

equipment supplied free in most cases by the hams, operated by them in practically all cases, the WERS stands ready to supplement public wire facilities should they fail in an emergency.

Licensing of amateurs was suspended after December 7th, but at the request of the War and Navy Departments the issuance of new operators' licenses was resumed early in 1942. The services advised the FCC that classification of men for Navy and Army radio duty is facilitated greatly if such persons who are qualified to hold a radio operator license are in a position to verify the fact by exhibiting the license.

Despite the present unsettled stage of the war, considerable discussion is under way concerning the post-war allotment of frequencies. Greater interest than ever is shown in this complex question for several reasons, outstanding among them being the prominent part communications has played in the present war, and the tremendous promise of things to come in the radio and electronic field. Unfortunately, the general idea among commercial interests, and most foreign governments, is to make their individual gains at the collective expense of the radio amateur. For the obvious reason that he is least able to protect himself, the ham becomes the most attacked individual at every international radio conference. It is a known fact that only the farsighted and staunch support given the amateurs by the Federal Communications Commission at Cairo, last of the international gatherings, saved the remaining ham frequencies. The sympathetic supervision and encouragement offered the amateurs by the FCC has enabled their number to grow to more than 60,000 licensed hams. This is convincing proof that the government recognizes the value of the radio amateur.

The amateur has in the American Radio Relay League an intelligent, active, and respected organization which acts as the official spokesman for the majority of licensed hams. But the ARRL has neither

the finances nor the influence to fight the battle of the radio amateur alone. The most vital force in America is public opinion. The record made by American hams in this war will be of great value to him in the future, as it has established his reputation more firmly in both military and civilian opinion.

At the present time, the status quo is in no danger because of general war-time restrictions, but the day may not be far off when a concerted drive may be necessary to counteract the highly organized vociferous lobbies of the commercial radio concerns.

Foreign governments have given far less encouragement to the ham than ours. This is due partly to economic conditions and partly because it is the will of the large, generally monopolistic, radio interests. Greedy for the space, whether they can use it or deserve it, most foreign powers look upon the radio experimenter as a potential criminal. It is noteworthy that our present enemies were among the worst in their suppression of amateur activity, though some United Nations countries were by no means blameless. Japan has been the amateur's Enemy No. 1 for many years. The refusal of intolerant governments to recognize the rights of the amateur might be used as a wedge to hold the door open on countless destructive proposals. Experience has shown, however, that the United States can be adamant in its arguments that our cooperation is more than necessary in any frequency allocation plan.

Today many of the technical improvements do come from laboratories, but commercial experimentation did not start until the amateur showed it would be a profitable venture. The greatest proving ground in the world for radio equipment is the ham field . . . and the fact they have done their work well is proven by the quality of our commercial equipment.

With tens of thousands of service men returning to private life with a new curi-



Members of the WERS take the FCC oath of secrecy during a demonstration in New York. Many active WERS members are amateurs, and the equipment is provided by their ingenuity.

osity about radio there is bound to be a tremendous expansion in the ranks of our 60,000 licensed amateurs. The radio amateur on the basis of his record should not only retain his present frequencies; he should be granted additional space. In the scramble for frequencies what private company will offer in its brief such a claim of public service to the nation, absolutely free? FM stations, television, facsimile, and such are all organized for profit, they offer at best a good dollar-for-dollar return.

We look forward to a post-war future in which the amateur will repeat his performances in the 200-meters-and-down region, to which he was exiled in 1912, and those of that mad period in the mid-twenties, in which he blazed the trail from 160 meters to 20, followed closely by the research departments of commercial communications companies, who, with all their resources and facilities, lagged behind until the ham pointed out the way. One-meter-and-down is the new field, and those who know him best have no doubt that the American ham will distinguish himself here as he has done all the way down the kilocycles, at all times turning his occupation of the new spectra to the public interest in time of peace and to government service should war conditions ever again arise.

The amateur has been one of the nation's best investments in the past and if he be given space to expand his hobby so that he may give proportionately greater service to the nation in war and in peace, will pay the United States a tremendous dividend.

PROGRESS IN INVENTION

(Continued from page 612)

conjunction with the cathode, an effective diode circuit is formed. The signal is thus detected, and after filtering through choke coil L and condenser C, the audio frequency appears across R3.

The audio signal is thus presented across the control-grid and ground and amplification takes place again. The amplified A.F. is developed across L2, C2, R2, which are of suitable dimensions, and may then be passed on for further amplification or to a loud-speaker.

Fig. 2 shows a circuit adapted to VTVM measurements. The voltage across Z1 is amplified by the pentode, appearing across Z2 at the output. This voltage is applied to the suppressor which in conjunction with the cathode is an effective diode.

The pulsating voltage is filtered out by R2, C2, and the resultant D.C. is applied to the control grid thus varying the position of the operating point on the characteristic curve. The decrease in average plate current is shown on the meter M.

R1 is designed to operate the effective diode at some desired value of bias, thus delaying the action of the grid detector until some definite signal amplitude is attained.

The device was invented by Frithiof B. Anderson, of Oakhurst, N. J., who recently received a patent for it. The patent has been assigned to the Bell Telephone Laboratories.

FORMER RADIO MAGAZINE EDITOR PROMOTED TO MAJOR

Capt. M. Harvey Gernsback, former associate editor of RADIO AND TELEVISION magazine, has been promoted to the rank of major, it was announced by the Signal Corps at Fort Monmouth, N. J., last month.

He is chief of the Radio, Wire and Miscellaneous Division in the Fort Monmouth Signal Corps Publications Agency, which produces training films and literature for communications troops.

Inducted into the army in January, 1941, Maj. Gernsback was graduated in the second class at Signal Corps Officer Candidate School at Fort Monmouth in January, 1942. He was promoted to first lieutenant in July, 1942, and to captain in March, 1943.

RADIO-CRAFT for JULY, 1944

HARRISON HAS IT!

**FOR URGENT
WAR WORK—**

HALLICRAFTERS

RECEIVERS AND
TRANSMITTERS

TUBES
CONDENSERS
RESISTORS
TRANSFORMERS

AND THOUSANDS OF OTHER
CRITICAL ELECTRONIC PARTS!

PURCHASING AGENTS—

Call upon us for your high priority requirements of equipment and components for your production and development work.

We usually have it in stock!

**FOR THE
HOME FRONT—**

CODE PRACTICE SET

Buzzer and key, heavily nickel plated, of single unit construction, mounted on wood base. Adjustable high frequency pitch. Complete with silk covered cord. In attractive box with code chart on cover. Works on one or two flashlight or dry cells.

Postpaid—\$2.45

6L6G First grade, \$1.37 ea.
TUBES meter tested, 3 for \$3.75
fully guaranteed postpaid

DYKANOL CAPACITORS

Cornell-Dubilier oil filled, hermetically sealed metal cased condensers. 4 mfd. capacity. Rated at 220 Volts AC working, will stand over 600 Volts D.C. Ideal for amplifiers, receivers, power packs, etc. (Filtering action equivalent to 12 mfd. electrolytic but with better safety factor, longer life). \$2.25 (3 or more shipped postpaid).

P. M. DYNAMIC SPEAKERS

5 inch, with output transformer to match single plate of 8000 ohms \$1.95

(Not Postpaid)

Immediate delivery of the above items, without priority, while quantities last. Place L-265 or V-3 certification on your order. SEND REMITTANCE WITH ORDER, TODAY! (Money back if not satisfied.)

HARRISON

RADIO CORPORATION

11 WEST BROADWAY

Phone WOrth 2-6276

NEW YORK CITY 7

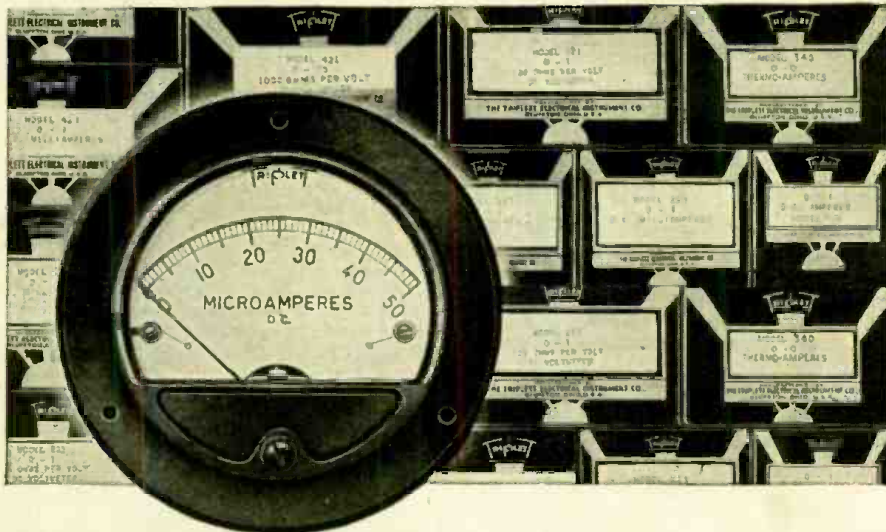

INSTRUMENT DELIVERIES!

War work has expanded Triplett production far beyond previous capacities and, with the experience of more than forty years of instrument manufacturing, has bettered the Instruments coming off the production lines.

Now—better instruments are ready for general use. Place your orders, at once, with Triplett—headquarters for instruments made to one fine standard of engineering.

- D'Arsonval Moving Coil D.C. Instruments
- Double Iron Repulsion A.C. Instruments
- Electrodynamometer A.C.-D.C.
- R.F. and Rectifier Types, Sizes 2" through 7"



TRIPLETT ELECTRICAL INSTRUMENT CO.

BLUFFTON • OHIO

HERE'S THE ONE PRACTICAL
WAY TO REALLY LEARN

RADIO ELECTRONICS and TELEVISION

FULL RADIO SET SUPPLIED

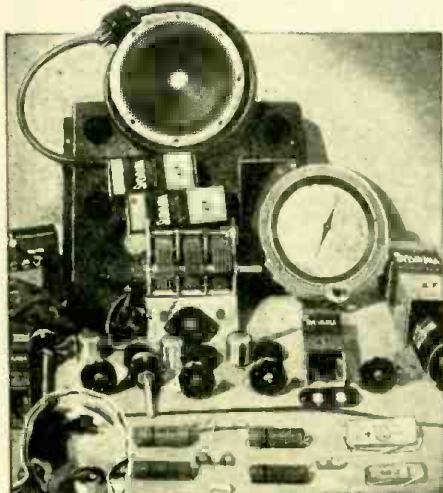

SPRAYBERRY TRAINING

Gives You

- ✓ TECHNICAL KNOWLEDGE
- ✓ SKILLED HANDS

GET READY FOR BIG EARNINGS

Here's your big chance to get ready for a wonderful future in the swiftly expanding field of Radio-Electronics INCLUDING Radio, Television, Frequency Modulation and Industrial Electronics. Be wise! NOW'S the time to start. No previous experience is necessary. The Sprayberry Course starts right at the beginning of Radio. You can't get lost.

**I'll Show You a New, Fast Way to Test
Radio Sets Without Mfg. Equipment**

The very same Radio Parts I supply with your course for gaining pre-experience in Radio Repair work may be adapted through an exclusive Sprayberry wiring procedure to serve for complete, fast, accurate Radio Receiver trouble-shooting. Thus under Sprayberry methods you do not have one cent of outlay for manufactured Test Equipment which is not only expensive but scarce.

**Prepares You for a Business of Your Own
or Good Radio Jobs...Civilian or Military.**

My training will give you the broad, fundamental principles so necessary as a background no matter which branch of Radio you wish to specialize in. I make it easy for you to learn Radio Set Repair and Installation Work. I teach you how to install and repair Electronic Equipment. Get the facts about my Training now. All features fully explained in my big illustrated catalog.



GET FREE BOOK

SPRAYBERRY ACADEMY OF RADIO
F. L. Sprayberry, President
Box 500TG, Pueblo, Colorado

Please rush my FREE copy of "How to MAKE MONEY in RADIO, ELECTRONICS and TELEVISION."

Name Age.....
Address
City State.....
(Mail in plain envelope or paste on penny postcard)

INDUSTRIAL ELECTRONICS

(Continued from page 593)

of suitable frequency. Such a combination not only severs flesh but also sears the freshly exposed tissue as it moves along, thereby bringing about coagulation and establishing a high degree of thermal sanitation. The bloodless operation has finally become possible and soon we shall see many other purely electronic devices entering the operating room.

For one thing, there is likely to be some form of electronic anesthesia developed from electronic shock therapy. Although it is not generally known, a large number of the unsuccessful cases operated die not from the operation itself but from complications traceable to the anesthesia, principally ether. "Ether pneumonia" is one of the most common ill effects and perhaps the most fatal of post-operative complications resulting from anesthesia. It is even possible that purely electronic equipment will be able to produce local forms of anesthesia. Another great advantage of complete anesthesia with the aid of electronics will be the total absence of nausea.

Naturally there has been a great deal of hope that electronic equipment of some sort may one day be found to eliminate cancer. The principal electronic devices employed today in this perennial search are the X-ray and the cyclotron, the latter a new hope.

Not so well known, however, are other forms of electronic equipment that might come to be of tremendous importance in this fight for life. For one thing, better diagnostic methods must be developed if the battle is to be fully won. The early stages may be corrected either with radium, X-ray or the knife. But in a place like the stomach or sections of the intestines, diagnosis is extremely difficult and uncertain.

The introduction of sensitive electronic equipment capable of measuring as little as 0.1 millivolt with accuracy has brought new possibilities to the medical profession. The employment of such equipment now makes the measurement of stomach potentials very easy and, curiously enough, it has been discovered through the use of such equipment that these voltages vary between 0.1 and 0.50 millivolts. The variations in voltage depend upon the condition of the lining of the stomach. When these readings are taken during digestive activity there is a voltage for a normal stomach, one for an ulcerous

and one for a cancerous stomach. The readings are taken with a vacuum-tube amplifier associated with a pen recorder mechanism. Such experiments have been going on for a long time and the perfection of a marvelously new and accurate diagnostic equipment appears to be near at hand.

An electronic microvoltmeter offers still greater possibilities. The differences in voltages generated by the healthy as compared to the malignant stomach are relatively large and therefore the equipment mentioned will be limited to diagnostic work associated with the stomach only.

It so happens that voltage changes in other parts of the body also indicate changes leading up to malignancy. So far this investigation has been limited to the breasts of mice and it has been discovered that certain voltage variations of tissue indicate that a malignancy will appear sooner or later. Such determinations may be made months before any other diagnostic method can be used.

In short, this sensitive electrical method points to a certain section of tissue and says, in effect, that in April, 1945, a cancer will appear here. This is perhaps the most promising of all clues now being investigated by those associated with cancer research. It would appear to be very close to the development of some sort of preventative therapy. The question before the researchers today is "What causes this change in voltage in tissue that has become susceptible to malignancy?"

Gradually the new science of electronics is demonstrating that the human system is a vast chemical apparatus and that its chemistry, as anyone familiar with electronics might expect, is invariably associated with voltage changes. This is a phenomenon of the interchange of valence electrons and—while perhaps a bit more complicated at times—the chemistry of the human system is no different than that of industry.

Although electronics has great promise in a number of fields, it would appear that one of the greatest is in the medical field or electro-therapeutic development. The time will come when every hospital must have one or more electronic engineers to watch over and use the enormously sensitive and complicated devices that are now taking form in laboratories all over the world.



Suggested by: PARKER RADIO SERVICE, Pittsburgh, Pa.

"Chuck de jewels, Spike, and got dat 12SA7 outta da midget!"

RADIO-CRAFT for JULY, 1944

THE RADIO ROCKET (Continued from page 594)

the rocket launcher if it stays at the same point for any length of time. For that reason, a caterpillar tractor is used so that the unit can quickly move to another location if necessary. The cover illustration also shows the mode of launching one of the two rockets from its rack. They are fired electrically by means of a contact device after they have been correctly aimed. This is standard practice today.

The Radio Rocket may be equipped with a transmitting and receiving aerial which trails behind, as shown in the illustrations. This, however, is not absolutely essential and it is probable that in the perfected Radio Rocket, actual aeriels may be dispensed with. One of our illustrations shows the construction of the rocket, which in addition to its warhead, also contains a gyroscope, necessary to keep it on its course. In addition, it carries a radio transmitter and a receiver.

Both the transmitter and receiver are very light and are operated by means of special batteries installed in the rocket. At the moment of launching, the transmitter goes into operation automatically. On a special short wave, it transmits a pulsating frequency which is easily picked up by two ground radio units, shown in our illustration. Using automatic triangulation means, the radio truck "A" and truck "B" plot the course of the rocket accurately during its flight. With electronic instruments the actual flight of the rocket can be observed visually on a special map whereby a moving light-spot illuminates the exact course the rocket is taking. Should it get off its pre-determined path, its flight is instantly corrected from the ground radio truck "B." This truck sends out a special radio wave—also on a short wave frequency—continuously from the instant the rocket is launched. If the light-spot on the map indicates that the rocket drifts over to the right and consequently is off its course, an automatic correction impulse to the rocket instantly corrects its flight. This can be accomplished wholly automatically by electronic means, such as special photo-electric cells, actuated by the moving light-spot. The flight correction is done by radio remote control, whereby either the movable elevators or horizontal rudders of the rocket can be deflected. This will then steer the rocket again on to its correct course. The radio technicians in their radio truck visually observe if the flight of the rocket has been corrected sufficiently. If it has not, it can then be further corrected if necessary.

It will be appreciated that the flight time of the Radio Rocket over a distance of even 100 miles is an exceedingly short one. Flying at the speed of a bullet the 100 miles take a scant 240 seconds! The means to correct the flight of the rocket therefore must be instantaneous, otherwise the rocket will not find its mark. Furthermore, the greater the distance over which the rocket travels, the easier it will be to correct its flight by purely electronic methods.

I have not endeavored in this article to go into many of the technical refinements and other necessary adjuncts which will make the Radio Rocket a most lethal weapon. There comes to the uninitiated the old interference bugaboo whereby the enemy will try by jamming or by other radio means to veer the Radio Rocket off its course. There is, however, very little likelihood that this can be accomplished for reasons which I have mentioned before in my other articles on Remote Radio Control. I repeat here that it is almost impossible to interfere with a radio-remote controlled device of this type and I have given the reasons for this in former articles.

Some writers are inclined to believe that the Radio-Controlled Rocket is THE most important weapon of the future. Huge rockets of this type weighing many tons can be shot over tremendous distances. They can be launched deep from within a mountainside where they can be effectively hidden. They are destined to take the place of the airplane, which will no longer be needed for bombing purposes, seeing that the long-distance Radio-Controlled Rocket can do the job much more effectively without any resulting loss of bombers and their crews.

ELECTRICITY

For Any Job Anywhere

For a dependable source of electricity on projects remote from commercial power, Onan Electric Plants are proven leaders in the field. More than half of the Armed Forces' total requirements for Power Plants are built by Onan.

Gasoline driven—single-unit Compact design sturdy construction sound engineering Suitable for mobile, stationary or emergency applications.

Over 65 models, ranging in sizes from 350 to 35,000 watts. 50 to 800 cycles, 110 to 660 volts, A.C. 6 to 4000 volts, D.C. also dual A.C.-D.C. output types.

Descriptive literature sent promptly on request. D. W. ONAN & SONS, 735 Royalston Ave., Minneapolis 5, Minn.

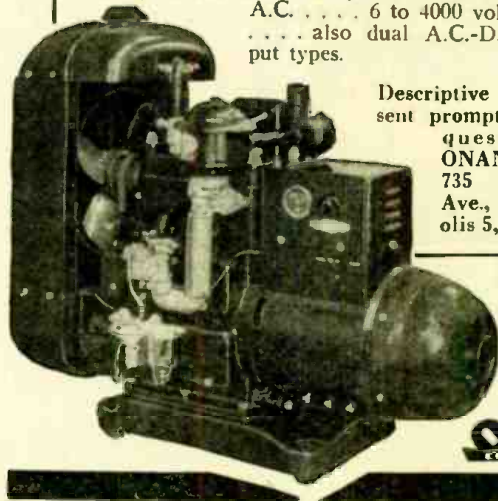

Replacement Tube Adaptors

Adaptor No.	Use Tube Type	To Replace Tube Type
1	#5U4G	#80—#5Z3—#83
2	#7A8	#12A8
3	#7C6	#12SQ7
4	#14A7	#12SK7
5	#35Z3	#35Z5
6	#14A7	#12SA7
7	#7A8	#12SA7
8	#1LA6	#1A7
9	#1LC6	#1A7
10	#43	#25L6
11	#7B7	#12SA7
12	#14B8	#12SA7
13	#14Q7	#12SA7
14	#14B6	#12SQ7
15	#39/44	#6K7
16	#7Y4	#6X5

\$1.25 List price, less 40% discount or 75 cents net, EACH

Many other types of tube adaptors available and coming in every day. 1/3 Deposit with Order. Balance of Order C.O.D.

Chicago Novelty Company, Inc.

1348 Newport Avenue

Chicago 13, Illinois

Proven!
 25,000 OHMS PER VOLT
 PUSH BUTTON OPERATED
 SPEED TESTER
 SUPREME MODEL
 592



- * Design proven by over 5 years production
- * Dual D.C. Sensitivity—25,000 ohms per volt and 1000 ohms per volt.
- * Matched resistors of 1% accuracy
- * Push button operated—no roaming test leads
- * Open face—wide scale 4 1/4" meter, 40 microamperes sensitivity.
- * 1 Microampere first scale division.

SPECIFICATIONS

- D.C. MICROAMPERES: 0-70-700 microamperes
- D.C. MILLIAMMETER: 0-7-35-140-350 milliamperes
- D.C. AMPMETER: 0-1-5-14 amperes
- D.C. VOLTS, 25,000 OHMS PER VOLT: 0-3-5-7-35-140-350-700-1400 volts
- D.C. VOLTS, 1000 OHMS PER VOLT: 0-3-5-7-35-140-350-700-1400 volts
- A.C. VOLTS, 1000 OHMS PER VOLT: 0-7-35-140-350-700-1400 volts
- OUTPUT VOLTMETER: 0-7-35-140-350-700-1400 volts
- DECIBEL METER: 0 db to plus 46 db
- OHMMETER: 0-500-5000-50,000-500,000 OHMS
0-3-30 MEGOHMS
- POWER SUPPLY: Battery Operated

With the above specifications the Supreme Model 592 Speed Tester meets today's requirements for general laboratory use, assembly line tests and inspection, radio and other electronic repair and maintenance.

SUPREME
 TESTING INSTRUMENTS

SUPREME INSTRUMENTS CORP.
 Greenwood, Miss., U. S. A.

good that several electrons have been jarred loose from their atoms and pulled toward the positive point. More ions start moving. These ponderous bodies bumping along create heat, which still further increases the ionization. We see a spark, a flash or a steady arc, depending on the amount of electricity behind our high voltage.

The whole area between the two points is a mass of hot, ionized gas. The arc has been "struck." The resistance of the air-space drops to a small fraction of the figure for a similar distance in normal air. Heat and chemical activity cause new ions to be formed continuously. The electrons then drift from atom to atom with only slightly more trouble than in a conductive metal.

The arc-light takes advantage of this fact. The two carbons of an arc are brought together and then separated, so that the arc is first struck over the very small distance between them as they are being separated. Once an arc is formed, the carbons are moved further apart.

FLOW IN PARTIAL VACUUM

Other than the electric arc, there is little use at present for this conduction of electrons in ordinary air. The atoms in air are so numerous and close together that they tend to swallow up any electrons they may get from the negative point, or to make up among themselves any losses they may suffer to the positive. Extremely high voltages are required for current flow, and this flow is very erratic once started.

If the two points are enclosed in a tube and a large part of the air taken out, we have a different situation. Electrons leaving the negative point may move a certain dis-

tance through the rarefied atmosphere before striking an atom. During this time they have a chance to gather some speed, and strike with enough of a wallop to knock off one or more electrons from that atom. Some or all of these electrons may proceed toward the positive point. (This point is called the *anode*, and the point from which electrons are emitted is the *cathode*, in electronic terminology.)

SPACE CHARGE AND CURRENT

A tube of this kind is called a Crookes tube, after the man who discovered this effect. He found that—with the hook-up of Fig. 2—as the air was nearly exhausted, current would start to flow, though the voltage across the tube's terminals was not nearly great enough to start an arc. As the pumping process was continued—still further reducing the amount of air in the tube—the current would increase. A point would soon be reached where the current would no longer increase, and further exhaustion of the tube beyond this point would cause a reduction of the flow inside the tube.

This drop in current puzzled Crookes, but is easy to understand now. The gas in the tube helped conduction in two ways. First, it supplied *secondary electrons* (electrons which did not start from the cathode but were released by collision). As the number of atoms in the atmosphere of the tube dropped, collisions were fewer, and consequently fewer electrons reached the anode. Second, the ions, drifting slowly toward the cathode in search of more electrons, built up a kind of positive ionic cloud, which attracted the electrons just leaving the cathode, speeded them up and made it easier for them to start out on their journey. With little or no gas in the tube, the cloud of electrons built up in the space around the cathode repels any electrons which seek to leave it.

THE HOT-CATHODE TUBE

Cold-cathode tubes have a limited use. We are most familiar with them in the common neon advertising signs. Small neon or argon-filled lamps are occasionally used in electronic devices (principally as voltage regulators or pilot lamps), and there is a tendency to use cold-cathode lamps in large fluorescent-lighting installations. Another type of tube is much more useful than those described.

This tube has a hot cathode, like an incandescent lamp. If the cathode is heated, conditions in our vacuum tube are entirely different. Metals "boil out" quantities of electrons when hot, much as boiling water does steam. See Fig. 3. High voltages are not necessary to urge them to leave the cathode—they come out themselves and hover in an electron-cloud in the space around it. Only a volt or two difference between cathode and anode is needed to start a drift in the direction of the positive anode. Tubes with a hot cathode can have a very high vacuum, and yet carry current. If they contain gas, they will pass very large currents at voltages only a fraction of what would be needed for cold-cathode tubes.

VACUUM-TUBE RECTIFIERS

The greatest advantage of the hot-cathode tube is that it conducts current *only one way*. It does not much matter which end is which in the cold-cathode tube. Only the hot element of the hot-cathode tube will emit electrons at the voltages at which



Suggested by: TOM JEWETT, Clyde, Ohio
 "You heard me! I said I want a new one!"

these tubes are commonly operated. If the electrical connections to the tube are interchanged, no current whatever will flow. This is very important, for it makes possible the use of this tube as a rectifier.

Most of the electricity supplied by our power companies is in the form of alternating current, which flows along the conductor first in one direction, then the other, usually for 1/120 second in each direction. It is often necessary to change this alternating current to direct current, for such uses as charging batteries or supplying a radio with power. Many chemical processes depend on direct current, as do certain types of heavy machinery. The hot-cathode electron tube is a simple and efficient device for straightening out this alternating current. A tube is simply inserted in series with the line. It passes all the electricity going one way, but stops all going in the other direction. As every other alternation is blocked off, the result is a series of pulses of current, all in the same direction. A network of choke coils and condensers smooths this pulsating direct current out into pure D.C. Fig. 4 is a rectifier circuit of the type used in practically all A.C.-D.C. radios. The part between the dashed lines is the filter, which smooths out the pulses, and has nothing to do with the actual rectification.

GAS AND HIGH-VACUUM TUBES

Rectifier tubes may or may not contain gas. Where small amounts of direct current are required at high voltages, the high-vacuum tube rectifier is used. Where large currents at low voltages are required, gas tubes, with cathodes of metals which emit a copious supply of electrons when hot, are used.

Many different varieties of both types of tubes are used in electronics. They range from the tiny 6H6, which rectifies the sometimes infinitesimal currents in your radio, to giant metal Ignitrons which look like large tanks. The cathodes of these great tubes are pools of mercury (the vapor from which provides the gaseous atmosphere for the tube), with special devices to keep a spot on the mercury surface hot enough to start the flow of electrons, and with pumps continuously running to keep up the vacuum in them.

All radio sets use rectifiers, as do most other types of electronic apparatus. So do many electric railroads, street-car lines and subways. Steel mills and aluminum plants are heavy users of direct current, and many metallurgical operations include the electrolytic deposition of metal, which requires direct current. There are also numbers of lighter industries in which D.C. is required, such as electroplating, charging batteries for electric trucks and certain types of electric locomotives. Most current is usually produced as A.C., so rectifiers are required. The electron tube is well fitted for this job, and is fast shouldering out all older means of changing A.C. to D.C. In wartime the electronic rectifier is especially valuable, as it uses less critical war material than the former rotary converter.

More details on the operation of the electron tube as rectifier, and an exposition of a still more important function of the tube, will form the subject matter of the next lesson.

NOTE—This series of lessons is written primarily for the man who already has a fair practical knowledge of electricity, and possibly some branches of electronics. Therefore such subjects as alternating current and why power companies find it more practical and convenient to produce electricity in this form rather than as D.C. are not explained. For the benefit of any readers who may not have any previous training in these subjects, it is recommended that a good electrical handbook be studied, such as Timbie's Basic Electricity for Communications (Wiley), or Albert's Electrical Fundamentals of Communication (McGraw-Hill).

LONG-DISTANCE TRANSMISSION WITH FM

FM transmission is practical over much longer distances than has heretofore been considered possible, declared Major Armstrong last month at the annual convention of the American Newspaper Publishers' Association.

"FM is now working up to three or four horizons" distant from the transmitter, he said, whereas only a few years ago it was thought to be limited in coverage to relatively small distances. Given suitable elevation for the sending antenna, he stated that FM "will outwork a standard 50-kilowatt broadcaster in most instances"; that FM also is "particularly effective for program relaying and rebroadcasting" and will make possible the linking of many stations in new networks "more cheaply and more effectively over substantial areas

than the present transmission over wire lines."

Major Armstrong urged the publishers to enter the FM radio field and furnish a wide public service to their communities, "communities which could never hope to have a station in the standard broadcast band."

PATENTS—TRADE MARKS

Booklet concerning Inventions & Patents Form "Evidence of Conception" with instructions for use and "Schedule of Government and Attorneys Fees"—Free

LANCASTER. ALLWINE & ROMMEL

Registered Patent Attorneys

436 Bowen Bldg.

Washington 5, D. C.

RADIO-ELECTRONIC REFERENCE-ANNUAL

PARTIAL CONTENTS RADIO-ELECTRONIC REFERENCE ANNUAL

ELECTRONIC THEORY AND GENERAL PRACTICE is thoroughly covered in this book in easy-to-grasp language. Among the articles on this subject are: What You Should Know About Electronics—Electronic Tubes for Servicemen—The Electronic Solovox, its theory and action—and The Photoelectric Photograph Pickup, the principles underlying its operation.

ELECTRONIC DEVICES YOU CAN BUILD Among the interesting and easily constructed devices selected are the following: Compact Hearing Aid—Oscillatex Automatic Key and Code Machine—Electronic Relays, Capacity and Light Oriented, High Frequency Radiography, a complete home apparatus—and many other timely types of electronic apparatus.

RADIO CONSTRUCTION Many well-illustrated, how-to-do-it articles, such as: Phono Oscillators, several types, adapted to playing records through your radio with a simple record player—T.R.F. Sets—Superheterodynes—Power Packs for Portable Receivers, making it possible to use your battery portable on the electric light line—A two-tube Super Midrange Amplifier, which is a Palm-of-the-hand Public address system—and many others.

SOUND AND RECORDING Including detailed instructions on constructing: High-Fidelity Amplifier—Exponential Horn with perfect reproduction down to 50 cycles—Electronic Expander, Compressor—Anchoring the Resonance Technique—Semi-Pro Recording—Electronic Bass and Treble Expanding Circuits—Equalizers, etc.

TEST INSTRUMENTS A complete line including: A Tube Checker with universal hookup; can check any tube regardless of the prong to which its elements are brought out—Compact Multimeter: 18 ranges of voltage, current and resistance on an 11-point, 2-gang switch—A Three Tube Signal Tracer, capable of checking R.F., I.F., and audio circuits—A Condenser Analyzer which measures both capacity and checks leakage—and an Electron-Ray Voltmeter which dispenses with hard-to-set milliammeters, using a 6E5 tube instead.

SERVICING Articles on servicing supply a multitude of methods and useful ideas, including: Dynamic Testing with Signal Generator—Measuring a Test Set—Calibrated UHF Oscillator—And countless other hints for ironing out kinks in your servicing problems.

1944



FREE—if you subscribe now to



Are you asking yourself: "What's next in Radio and Electronics?" What mysterious inventions are brewing in radio research laboratories? What effect will these wartime secret inventions have on peacetime conditions? Will the scientists take me into new, unfamiliar fields, requiring special technical education?

Keep Posted With Radio-Craft
Radio is once again at the crossroads! All must become students again of a science that has experienced a marvelous rebirth through ELECTRONICS. The question about the near and distant future now racing through your mind will be answered step by step in the forthcoming issues of RADIO-CRAFT.

You Need This Free Reference Annual, Too!
You can't plan intelligently ahead—you can't grasp the new—until you have thoroughly mastered the tried and accepted present-day radio developments. And that is where the REFERENCE ANNUAL comes to your aid. This fact-packed book is THE radio man's digest. It's the spark that bridges the gap between the RADIO-ELECTRONIC WORLD OF TODAY and the COMING POST-WAR WORLD.

And think of it—you can get it absolutely free and postpaid by subscribing to RADIO-CRAFT now—but you must act quickly as war-paper shortage compels us to limit the printing. If you are already a subscriber we can extend your subscription.

CUT OUT AND MAIL

TIME LIMIT OFFER

RADIO-CRAFT WITH FREE COPY RADIO-REFERENCE ANNUAL

- 1 Year \$2.50
- 2 Years \$4.50
- 3 Years \$6.00

If you are already a subscriber we can extend your subscription if you will check "Extension" box.

Temperature 60° C

Catalog Number	Type			
	10,000 kc.	3000 kc.	1000 kc.	300 kc.
1590-217				
1590-218	16.	20.	15.	
1590-219	16.	20.	15.	
1590-220	18.	20.	17.	
1590-221	18.	20.	18.	
	18.	23.	20.	
1590-222				
1590-223	18.	25.	22.	
1590-224	18.	25.	22.	
1590-225	18.	25.	22.	
1590-226	18.	25.	22.	
	18.	25.	22.	
1590-227				
1590-228	18.		22.	
1590-229				
1590-230				
1590-231				
1590-232				
1590-233				
1590-234				
1590-235				
1590-236				
1590-237				
1590-238				
1590-239				
1590-240				
1590-241				
1590-242				
1590-243				
1590-244				
1590-245				
1590-246				
1590-247				
1590-248				
1590-249				
1590-250				

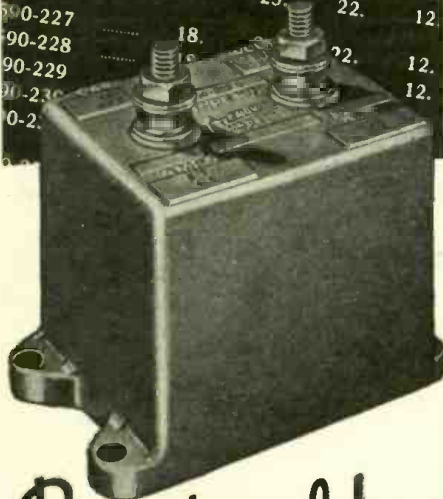

Backed by the most complete CONTINUOUS SERVICE RATING DATA

• Aerovox mica transmitting capacitors are backed by exceptionally complete data on maximum current-carrying ratings at five different frequencies in addition to capacitance and test-voltage ratings. Such data is the accumulation of years of research and experience and exhaustive tests. Thus the unit best suited for given voltage and frequency is selected quickly and precisely. Good capacitors, PLUS good application data, accounts for the tremendous popularity which Aerovox

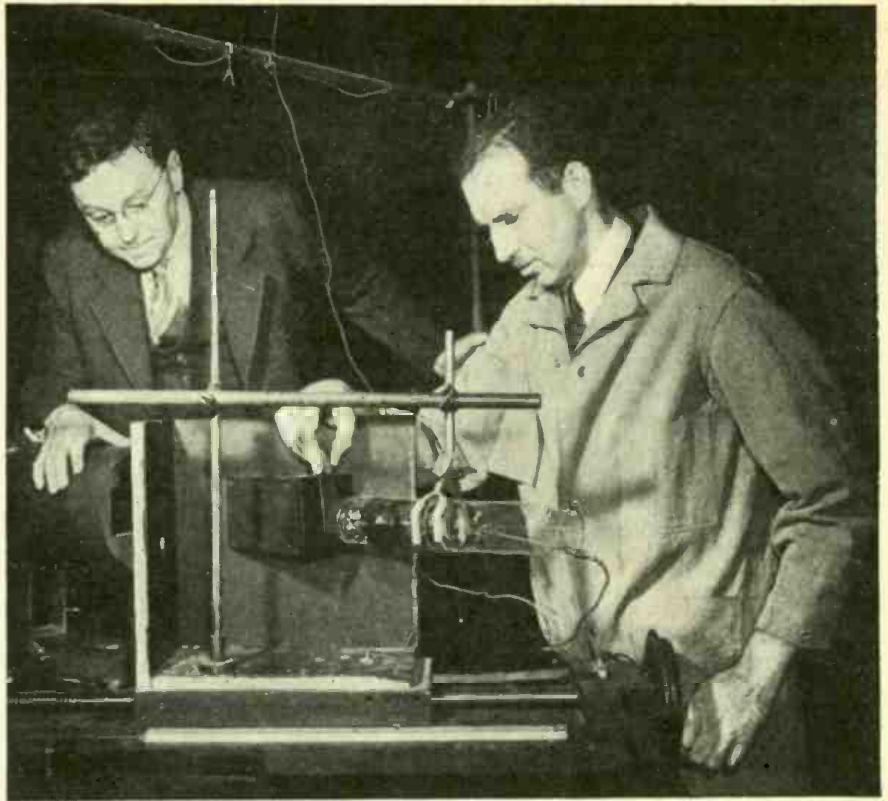

The violet-ray sensitive phototube which measures suntan undergoing laboratory tests.

Check Your Sun-Tan Electronically!

FISHERMEN sometimes carry along thermometers to determine whether temperatures of fishing waters are just right for trout or bass angling. Similarly during the summer of 1944, bathers, beach visitors, roof loungers, and just plain unadorned seekers after a suntan may telephone the United States Weather Bureau and determine where and when suitable sunburns may be acquired. Suntan electronic tubes—first cousin to radio tubes—have been developed by the Westinghouse Electric and Manufacturing Company, and Uncle Sam is establishing 20 suntan stations over a 1,000-mile stretch of territory—ranging from Texas, through the Mississippi Valley, to the colder region of the Middle West.

These extremely sensitive suntan or electron tubes—which ordinarily perform such duties as opening doors, sounding burglar alarms, pounding speakers' gavels, and arousing sleepwalkers—are to record, day after day, year-around, the amount of ultra-violet light, or suntan rays, filtering through to earth. While bathers and other outdoor devotees may gain usable information from these new suntan tubes, their greater and ultimate usefulness is to determine the effect of ultra-violet radiation on war workers of the nation—and to see whether tan-rays affect the weather in general. Thus, sunfall measurements may prove of value to farmers, agricultural colleges, meteorologists, and physicians.

Already scientists have garnered some little-known but intriguing information about those rays of sunshine which produce sunburn, in varying degrees. Suntan rays may vary from day to day, and particularly from season to season. Notably, in some areas of the United States, October is the month wherein the outdoor enthusiasts may obtain a maximum degree of suntan. Yet, in the popular mind, June, July

and August are the months when our bodies should be exposed to the sun, if we are to benefit by those rays that are equivalent to an internal dose of cod-liver oil. Suntan stations at LaGuardia Field, New York, and in Boston and Cambridge, Mass., will determine whether city smoke and dirt exclude the beneficial ultra-violet rays.

The new suntan tubes have the appearance of "big brother" radio tubes. They are more than a foot long and about two inches thick. Naturally, they are set ends upward, toward the heavens, and their rounded caps of glass are "standing invitations" for the sun to enter. Under this rounded cap, in a vacuum, is a metal disc about the size of a 50-cent piece. This is extremely sensitive to ultra-violet rays. When the latter strikes the upper side of this metal, a bit of electricity shoots out of it. This bombardment of electrons goes down the tube to be amplified a million times—strong enough to actuate a mechanical counter. Literally, this robot counter keeps tab on ultra-violet sunshine, ray by ray, day by day.—S. R. W.

CORRECTION

Two errors appeared in the June issue. An incorrect connection puts the grid condenser of the transceiver on page 543 between the grid and the two grid leaks, resulting in a completely blocked grid. The lead from the grid should go to the switch between points R and T, and the grid condenser should be between this point and the connection of L₁ and C₁.

In the time delay on page 548, the variable resistors mentioned in the text were erroneously drawn as variable condensers. They are, however, correctly described as resistors in the text.

FOR SALE HARD-TO-GET ITEMS

All items are brand new, except where indicated. ALL are in PERFECT WORKING ORDER. In many cases, the parts alone total more than the price we are asking. Satisfaction guaranteed or your money back. ORDER FROM THIS PAGE. Use our convenient coupon. Include sufficient for C.O.D. shipments on orders for less than \$5.00. If full remittance accompanies order deduct 2% discount. Send money order, certified check, or new U. S. stamps. No C. O. D.'s to foreign countries.

ULTRA MAGNET

LIFTS MORE THAN 20 TIMES ITS OWN WEIGHT

LITTLE GIANT MAGNET

Lifts 5 lbs. easily. Weighs 4 oz. Made of ALNICO new high-magnetic steel. Complete with keeper. World's most powerful magnet ever made. The experimenter and hobbyist will find hundreds of excellent uses for this high quality permanent magnet. Measures 1 3/4" x 1 1/2". Ship. Wt. 5/8 lbs.
ITEM NO. 159
YOUR PRICE **\$1.25**



GENUINE MICROPHONE TRANSMITTERS

These are regular "telephone" transmitters of the type used on wall telephones. Taken from a large telephone supply company's overstock, these fine mikes offer a grand opportunity to obtain a splendid unit for little more than the price usually asked for a simple "microphone button". The amateur experimenter and telephone mechanic will find a variety of uses for these excellent microphones. They work perfectly on 2 dry cells.

Can be used on P.A. systems for voice transmissions, in call systems and intercommunications sets. With telephone receivers (radio headphones will do) they may be made into short-line telephone circuits, such as house-to-house or farm-to-farm phone lines. You can use them to talk through your own radio, or as concealed dictaphone pick-up units for listening to conversations in a distant room or building. The telephone mechanic will find them useful replacements on battery-operated rural telephone lines.

THESE ARE GENUINE TRANSMITTERS. MADE BY KELLOGG, WESTERN ELECTRIC AND STROMBERG-CARLSON. Excellent in appearance and operation. A remarkable value and one seldom offered in these times. Ship. Wt. 1 lb.
ITEM NO. 160
YOUR PRICE **\$1.50**

AMAZING BLACK LIGHT!

Powerful 250-Watt Ultra-Violet Source

The best and most practical source of ultra-violet light for general experimental and entertainment use. Makes all fluorescent substances brilliantly luminescent. No transformers of any kind needed. Fits any standard lamp socket. Made with special filter glass permitting only ultra-violet rays to come through. Brings out beautiful opalescent hues in various types of materials. Swell for amateur parties, plays, etc., to obtain unique lighting effects. Butb only. Ship. Wt. 1 lb.
ITEM NO. 87
YOUR PRICE **\$2.45**

WATT HOUR METER

Completely overhauled and ready for immediate service. Designed for regular 110 volt, 60 cycle 2-wire A.C. circuit. Servicemen use it in their shops to check current consumption of sets, soldering irons, etc. Keeps coats down. If dismantled, the parts should be brought back to the price. The elaborate gear train could be used as a counter on machines of various kinds. Simple to install: 2 wires from the line and 2 wires to the load. Sturdily constructed in heavy metal case. 8 1/2" high, 6 1/4" wide, 5" deep. Westinghouse, C. E. St. Wayne or other available make. Ship. Wt. 14 lbs.
ITEM NO. 33
YOUR PRICE **\$5.95**



LIMITED QUANTITIES! PROMPT SHIPMENTS!

It's Easy to order—Clip Coupon—Order from This Page—No Catalog Sent.
MAIL TODAY—NOW!
(See Corresponding Ad. Page 635)

HUDSON SPECIALTIES CO.

40 West Broadway, Dept. RC-7-44, New York 7, N. Y.

I have circled below the numbers of the items I'm ordering. My full remittance of \$... is enclosed (NO C.O.D. ORDERS UNLESS ACCOMPANIED WITH A DEPOSIT.) OR my deposit of \$... is enclosed (20% required) ship order. C.O.D. or balance. NO C.O.D. ORDER FOR LESS THAN \$5.00. (New U. S. stamps, check or money order accepted.) Circle Item No. wanted: 33 87 159 160

Name _____
Address _____ Please Print Clearly
City _____ State _____
Send remittance by check, stamps or money order; register letter if you send cash or stamps.

WORLD WIDE STATION LIST

(Continued from page 608)

- 9.730 CE970 VALPARISO, CHILE; evenings.
- 9.735 CXA15 MONTEVIDEO, URUGUAY; evenings.
- 9.740 CSW7 LISBON, PORTUGAL, North American beam, 9 to 10 pm.
- 9.750 — ROME, ITALY.
- 9.750 WKLJ NEW YORK CITY; North African beam, 5:15 to 7 am; 3:30 to 8 pm.
- 9.760 — "RADIO DEUTSCHER KURZWELLEN SENDER ATLANTIC"; last heard Sunday afternoons.
- 9.785 OTC LEOPOLDVILLE, BELGIAN CONGO; 5:45 to 6:35 pm; 8:15 to 8:45 pm; other times.
- 9.825 GRH LONDON, ENGLAND; 1 to 4:30 am; 11:30 am to 12:45 pm.
- 9.830 GRX LONDON, ENGLAND.
- 9.833 COCM HAVANA, CUBA; 10 am to 11 pm.
- 9.833 XPRA KUNMING, CHINA; 6 to 9 am.
- 9.840 — HUNGARIAN NATIONS RADIO; heard Sundays, 3:15 to 3:26 pm.
- 9.845 — RADIO NAZIONALE FASCISTI; unheard of for several months.
- 9.860 EAQ MADRID, SPAIN; 1 to 3 pm; 6:40 to 7:13 pm; 7:20 to 8 pm.
- 9.865 — MOSCOW, USSR; 7 to 8 am; 10:40 am; 7 to 7:25 pm; 8 to 8:45 pm.
- 9.870 — "PRAHEVA"; not heard in recent months.
- 9.880 CR7BE LOURENCO MARQUES, MOZAMBIQUE; 6 to 8 am; 3 to 5 pm.
- 9.880 — MOSCOW, USSR; 11 am to noon.
- 9.895 — BULGARIAN FREEDOM STATION; last heard in afternoons.
- 9.897 WKRD NEW YORK CITY; European beam, 3:45 to 5:45 am.
- 9.897 KROJ LOS ANGELES, CALIF.; Oriental beam, 10:15 to 11:15 pm.
- 9.897 WKRX NEW YORK CITY; North European beam, 6 to 8:45 pm.
- 9.905 — RADIO DAKAR, FRENCH WEST AFRICA; heard 2:45 to 5 pm.
- 9.958 HCJB QUITO, ECUADOR; 9 to 9:45 am; evenings.
- 10.000 WWV BELTSVILLE, MARYLAND; U. S. Bureau of Standards.
- 10.045 XUB CHUNGKING, CHINA.
- 10.050 XBHX MEXICO CITY, MEXICO; 8 am to 8 pm.
- 10.065 MTCY MANCHUKUO; last heard during early am.
- 10.130 HH3W PORT AU PRINCE, HAITI; 1 to 5 pm; 7 to 11:30 pm.
- 10.22 PSH RIO DE JANEIRO, BRAZIL; 7 to 8:15 pm; 8:30 to 9 pm.
- 10.260 XGAP PEIPING, CHINA; under Japanese operation, 9 to 11 am.
- 10.285 ZNR ADEN, ARABIA; no schedule known to us.
- 10.290 DZC BERLIN, GERMANY.
- 10.338 — BERN, SWITZERLAND; North American beam, 3:45 to 4:15 pm except Saturdays.
- 10.380 — STATION DEBUNK; not heard recently.
- 10.445 — MOSCOW, USSR; schedule not known.
- 10.48 COCH HAVANA, CUBA; evenings.
- 10.543 DZD BERLIN, GERMANY.
- 10.620 KES3 SAN FRANCISCO, CALIF.; Oriental beam, 1 to 6 am.
- 10.75 — RIO DE JANEIRO, BRAZIL; carries PRLB programs.
- 10.840 KWW SAN FRANCISCO, CALIF.; Australian beam, 2 to 4:45 am; South American beam, 5 to 7 am.
- 11.145 WCBN NEW YORK CITY; European beam, 6 to 8 am.
- 11.500 VPL10 BARBADOS, BRITISH WEST INDIES; heard testing on a Sunday afternoon.
- 11.69 XGR5 SHANGHAI, CHINA; 11:15 am to 12:30 pm.
- 11.705 SBP STOCKHOLM, SWEDEN; 2:45 to 3:10 am; 7 to 7:55 am; 11 am to 2:15 pm; 2:30 to 5:15 pm; 9 to 10 pm; Sundays only, 4 am to 2:15 pm.
- 11.718 CR7BH MAROUI, MOZAMBIQUE.
- 11.790 WRUA BOSTON, MASS. North African beam, 1:45 to 4:30 pm.
- 11.855 DJP BERLIN, Germany.
- 15.130 WRUS BOSTON, MASS.; North African beam, 4:45 to 6 pm.
- 15.230 — MOSCOW, USSR; off at 7:25 pm.
- 15.330 WGE0 SCHENECTADY, NEW YORK; European beam, 7 am to 3:30 pm; 3:45 to 5:15 pm.
- 15.350 WRUW BOSTON, MASS.; European beam, 2:45 to 6 pm.
- 15.400 GRE LONDON, ENGLAND; heard in afternoon.
- 15.750 — MOSCOW, USSR; heard mornings.
- 16.000 EPA TEHERAN, IRAN; operated by AFHQ; heard Sunday at 4:12 pm.
- 17.773 OTC LEOPOLDVILLE, BELGIAN CONGO.
- 17.880 WGEX SCHENECTADY, NEW YORK; European beam, noon to 4:45 pm.

Your best bet!

FREE Complete Up-to-date BUYING GUIDE

..for everything in RADIO and ELECTRONICS

SAVE TIME Call ALLIED First!

REPAIR and REPLACEMENT PARTS AVAILABLE without priority

The world's largest stocks are centralized in this single arsenal

of supply. Over 10,000 items from all leading manufacturers . . . for the Armed Forces, Radio Training, Research Laboratories, War Industries and Service Replacements. Our experienced staff helps speed delivery. Save time—simplify procurement—call ALLIED first! Thousands do.

Write, wire or phone Haymarket 6800.



6 Radio Books for 75c

- Dictionary of Radio Terms. No. 37-731 10c
- Radio Data Handbook. No. 37-754 25c
- Radio Circuit Handbook. No. 37-753 10c
- Radio Builders Handbook. No. 37-750 10c
- Radio Formulas & Data Book. No. 37-752 10c
- Simplified Radio Servicing. No. 37-755 10c
- All Six Books No. 37-799 . . . 75c

Write for Quantity Prices

ALLIED RADIO CORP., Dept. 2-G-4
833 W. Jackson Blvd., Chicago, Ill.

Please send following books (.....c enclosed):

- FREE 37-750 37-752 37-754
- Buying Guide 37-751 37-753 37-755
- No. 37-799 (All Six Books)

Name _____

Address _____

City _____ State _____

ALLIED RADIO

THE LATEST UP-TO-THE-MINUTE RADIO AND ELECTRONIC CATALOG IN THE COUNTRY TODAY!



Just Published!

Newest listings of amplifiers, communications equipment, radio tubes, testers, etc. • The latest developments in intercommunications equipment. • Greatly expanded listing of needed tools, especially for assembly and factory use. • Advance listings of 1944 radio and electronic books; repair and replacement parts; bargain section of values. • A brand new, up-to-the-minute catalog that should be in the hands of industrial plants, laboratories, government and military services, schools, radio servicemen and dealers (on L265), everybody engaged in vital war and civilian work.

FREE! The Lafayette Radio Catalog No. 94 will be rushed to you upon request. Fill out this coupon NOW!

LAFAYETTE RADIO CORP.
901 W. Jackson Blvd., Chicago 7, Ill.
Dept. RC-7
Please rush my FREE copy of the Lafayette Radio Catalog No. 94.

NAME

ADDRESS

CITY..... STATE.....

*Back the Attack -
Buy More War Bonds*

**LAFAYETTE
RADIO CORPORATION**

901 W. Jackson Blvd.
CHICAGO 7, ILLINOIS
265 Peachtree Street
ATLANTA 3, GEORGIA

POWER FOR PORTABLES

(Continued from page 599)

of wiring changes. In general, all grounds are made to the chassis speaker lug except the grounds for the power supply filter condensers and the ground for the 300-ohm shunt, which are made at the two most convenient points of the chassis.

No. 27 push-back wire should be used for rewiring, as it won't take up much space. However, it is difficult to obtain and No. 20 will probably have to be used.

POWER SUPPLY ADJUSTMENTS

Since there is very little information on the "floating" of the dry batteries across the power lines a few statements may help to clear up questions which may arise. For the set to operate on the power supply and draw no current from the "A" or "B" batteries, the 2,500-ohm adjustable resistor in the "A" supply should be adjusted so that a zero reading is obtained on a milliammeter (range 0-15 MA) when inserted in the A+ battery lead at a point close to the battery terminal. Similarly in the "B" circuit the 3,500-ohm resistor should give a zero

set is operating wholly on the power supply. If desired a slight current can be passed through the batteries as it has been claimed by some to have a recharging action on the dry cells. However, this is still a "moot" point. Refer to an article, "Rejuvenating Dry Batteries" by Benjamin S. Vilkomerson on page 51 of the July, 1941 issue of *Radio-Craft*, also to an article, "Can Dry Cells Be Renewed," on page 603 of the July, 1943 issue of *Radio-Craft*.

As is common practice with A.C.-D.C. equipment, no outside ground should be used and the set itself should not be placed on a metal radiator or grounded object. In those sets where the chassis is enclosed by a plastic cabinet, no danger of shock or power line shorting should be encountered. However, it is well to remember that in nearly all A.C.-D.C. equipment if the power line is plugged wrong, the chassis will be "hot" and there is danger of shock and shorts if the unit is grounded. It is always well to use a fused A.C. plug on A.C.-D.C. equipment if it is obtainable. On these type

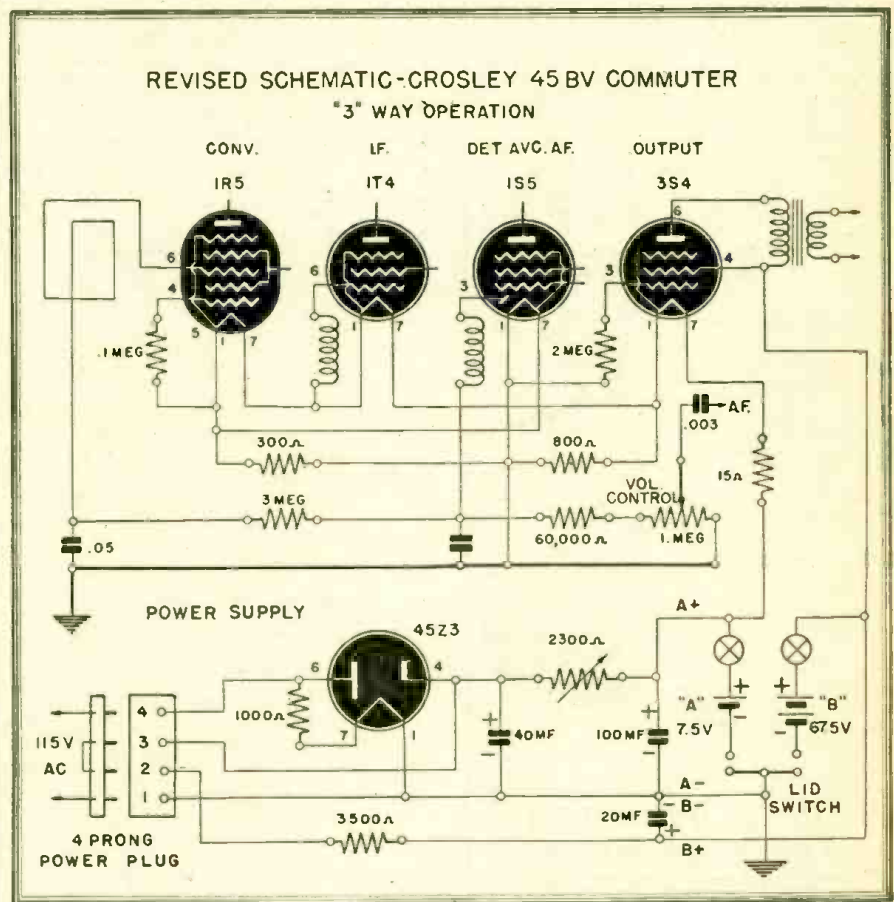

Fig. 3—How the finished receiver looks. Two tubes, the 3S4 and the 45Z5, do not appear in the original schematic. The power plug is hooked up to also protect the battery circuit.

milliammeter reading when the meter is inserted in series with it. If it does not, it should be replaced by one which does give a zero reading. Remember this, if the milliammeter reads a positive current the battery is supplying this amount of current, if it reads a negative current the power supply is passing this amount of current into the battery. This assumes of course that the positive side of the meter is connected to the positive pole of the dry battery. If the meter reads zero, no current is entering or leaving the battery and the

sets 1 or 2-ampere fuses should be used in the plugs.

In a compact set such as this the rectifier tube as well as the 2,500-ohm "A" supply resistor and 1,000-ohm filament dropping resistor will dissipate considerable heat. If possible ventilation holes should be drilled in the top and bottom of the case to create a draft. If the set is to be used continually on A.C., it would be well to remove the batteries as heat has a deteriorating action on all dry cells.

(Continued on opposite page)

**GEOPHYSICAL
PROSPECTING
PRINTS
(TREASURE
FINDERS)**

**50¢ EACH
7 FOR
\$3.—**



LAND-MINE LOCATOR

With any one of the modern geophysical methods described in the Blue-Print patterns, radio outfits and instruments can be constructed to locate metal and ore deposits (prospecting); finding lost or buried treasures; metal war relics; sea and land mines and "duds"; mineral deposits; subterranean water veins; oil deposits (under certain circumstances); buried gas and water pipes; tools or other metallic objects sunken in water, etc., etc.

Folder No. 1. Radioreceptor Pilot. Construction and use of 2 tube transmitter and 3 tube receiver. Rectified wave principle. Visual and aural signals.

Folder No. 2. Harmonic Frequency Locator. Radiates low frequency wave to receiver. Aural signals.

Folder No. 3. Beat Note Indicator. 2 oscillators. Visual and aural signals.

Folder No. 4. Radio Balance Surveyor. Balanced loop principle. Modulated transmitter. Visual and aural signals.

Folder No. 5. Variable Inductance Monitor. Inductance principle. Aural signals.

Folder No. 6. Hughes Inductance Balance Explorer. Bridge principle. Aural signals.

Folder No. 7. Radiodine Prospector. Balanced loop principle. Very large field of penetration. Aural signals.

Each set of blueprints and instructions enclosed in heavy envelope (9 1/2" x 12 1/2"). Blueprints 22" x 34"; eight-page illustrated 8 1/2" x 11" folder of 50c instructions and construction data. Add 5c for postage.

The complete set of seven folders **\$3.00**
Shipping weight 2 lbs. (add 25c for shipping anywhere in U.S.A.)

Send Stamps, Cash or Money Order to

TECHNIFAX

1917 S. STATE ST. RC-7-44 CHICAGO, ILL.

TECHNIFAX 1917 So. State, Chicago, 16, Ill.

Enclosed herewith \$..... for which mail to address below:
Treasure Finder No. 1, 2, 3, 4, 5, 6, 7.
Complete set of seven folders.

NAME
ADDRESS
CITY STATE
RC-7-44

Complete Plans

For Building Useful and Practical Things at Home. Each issue of Popular Homecraft is crammed with plans for making such beautiful and useful things as: Furniture, Bird Houses, Lamps, Outdoor Garden Furniture, Candle Equipment, etc. Covers leather work, tools, wood-working, leathercraft, etc. P.P.T. You'll find "how" to make almost everything from the pages of Popular Homecraft. Scores of drawings and photographs make every step simple as A B C. A real "How-To-Do-It" magazine.



Six Months' Trial \$1.00

Send \$1.00 today for trial six months' subscription. Money Back if Not Delighted.

POPULAR HOMECRAFT

637 Palmolive Building CHICAGO, ILL.

Trial 6 Months \$1.00

Britain's radio offensive occupies 26 wavelengths and is carried on in 24 languages. Over 600 people are employed in the "radio blitz" and it is estimated that a secret audience of more than 200,000,000 people listen.

This set operates very nicely on A.C., with batteries in place, by plugging one end of the line cord into the set and the other end into the 115-volt A.C. supply. No hum can be heard and the volume is greater than when the set is operated on batteries. The set can also be operated on A.C. without any batteries. To shut the set off, the A.C. power plug must be pulled out as the ON-OFF switch in the lid shuts off only the "A" and "B" batteries.

This set operates in the usual manner with batteries, that is, it starts to play when the lid is raised and stops when the lid is closed. As previously explained, the power cord must be disconnected from the set via the 4-prong plug when the set is used on batteries to prevent heavy "B" current drain. The pen-light cells as used give battery life equal to or slightly longer than the 1.5-volt flashlight cell used in the original hook-up.

This conversion produces a real 3-way portable which will work on 155-volt A.C. or D.C. current or on batteries, and one which weighs less than four pounds complete with built-in power supply and batteries.

Parts List

RESISTORS

- 1—1000-ohm 10-watt, IRC type AB
- 1—2500-ohm 10-watt adjustable, IRC type ABA
- 1—300-ohm 1/2-watt, IRC type BT-1/2
- 1—3500-ohm 1-watt, IRC type BT-1
- 1—15-ohm 1/2-watt, IRC type BT-1/2

CONDENSERS

- 1—40MFD, 150-volt, Cornell-Dubilier, type BR-4015
- 1—20 MFD, 150-volt Cornell-Dubilier, type BR-2015
- 1—100 MFD, 15-volt, Cornell-Dubilier, type BRH-151

TUBES

- 1—45Z3 Rectifier tube
- 1—354 Vacuum tube

MISCELLANEOUS

- 1—AC line cord and plug. (Fused plug with 1-amp. fuses if obtainable)
- 1—4-prong hearing aid socket, Amphenol No. 77-26
- 1—4-prong hearing aid plug, Amphenol No. 70-26
- 1—Miniature socket, wafer type, for 45Z3 tube

BATTERIES

- 5—Pen-light cells 1.5-V.
- 1—67.5-volt "B" battery Eveready No. 467 Minimax

THE first successful sight-and-sound broadcasts in Uruguay on amateur equipment—developed in the face of wartime technical handicaps—has gained for Mario Giampietro, a youngish, self-schooled radio technician, recognition as South America's television pioneer, according to a report received by the International Department of the RCA Victor Division.

Giampietro, radio tinkerer and "ham" since 1924, has staked out a claim as being the first South American to broadcast successfully over distances of more than a mile.

A conspicuous exception to the time-honored assertion that "a prophet is not without honor save in his own country," unassuming Giampietro has received official recognition from the Uruguayan government, which granted him an experimental wave length and authorization to use CXHAQ as his call letters.

The telecasts were so impressive that progressive Radio Carve, Uruguay's largest broadcasting station, took Giampietro under its wing and is now reported to be planning a commercial company to finance further experiments, including one whose details are being kept secret.

PREPARE NOW!
FOR A BETTER FUTURE

Learn RADIO ELECTRONICS
The A-B-C
DeFOREST'S WAY AT HOME

What will YOU be doing AFTER the War?

ASK YOURSELF THESE 3 QUESTIONS

1. What's going to happen to my present job when Peace comes? ... when war production ends?
2. Have I the skilled training that could lead to a preferred job at good pay in peacetime industry—or to start a business of my own?
3. Have I considered the many good present jobs and future opportunities in the billion-dollar Radio-Electronics industry?

GET INTO THIS BRIGHT OPPORTUNITY FIELD OF TODAY AND TOMORROW

TODAY—A working knowledge of Radio-Electronics can help you to a better job and good pay check in Essential Industries. It can pave the way toward a part-time or full-time Radio-Electronics Sales and Service *Business of Your Own*. Or—if you are eligible for military service—it can help you toward better military ratings and higher pay.

TOMORROW—FM Radio, AIRCRAFT Radio, RAILROAD Radio, MARINE Radio, POLICE Radio, and other exciting branches of the Billion Dollar Radio-Electronics Industry will need trained men. Motion Picture Studios and Theatres ... Radio Picture Projection ... the increasing use of **PUBLIC ADDRESS SYSTEMS** by Industrial Plants, Stores, Offices, Schools, etc. ... the peacetime uses of such war-born discoveries as **RADAR** ... **INDUSTRIAL ELECTRONICS**—all promise bright futures for trained men.

YOU GET A 3-WAY TRAINING

DeForest's Training teaches you Radio-Electronics at home with the aid of: (A) a genuine DeVry movie projector and instructive movie films to help you "learn by seeing" faster, easier. (B) 8 big kits of Radio parts and assemblies for working out 133 Radio experiments, and (C) 90 illustrated lessons prepared under the supervision of Dr. Lee DeForest, often called the "Father of Radio." You READ ... you SEE ... you WORK ON EQUIPMENT AT HOME ... the DeForest's Way! And when trained, you get real **EMPLOYMENT SERVICE**. Send for Complete Information. Simply PRINT name and address neatly on coupon below—and mail it today!



DeFOREST'S TRAINING INCLUDES INSTRUCTION IN MOTION PICTURE SOUND EQUIPMENT, FM RADIO, AND TELEVISION

"Learn-by-Doing" at Home with Practical Equipment.



DeFOREST'S

DeFOREST'S TRAINING, INC.
2533-41 N. Ashland Ave., Dept. RC-6
Chicago 14, Illinois.

Without cost or obligation, send me "VICTORY FOR YOU" book and KIT FOLDER—showing how I may prepare to make my start in RADIO-ELECTRONICS.

Name.....

Address.....

City.....

State..... Age.....

Check here, if under 16, for Special Information

CAREERS

for ENGINEERS

at NATIONAL UNION RADIO CORPORATION

You who join our research and engineering staff now to help us with the important war work we are doing will be embarking on a career. Our plans for the future offer unusual opportunities for able men. Our staff today forms a friendly capable team of scientists and engineers whose accomplishments have brought national recognition. You'll enjoy working with them, growing with them.

THESE ARE OPPORTUNITIES. We are adding to our staff engineers who specialize in

ELECTRONIC TUBES
PRODUCTION
DEVELOPMENT
MEASUREMENTS
PHYSICS
ELECTRICITY
TRANSMITTING TUBES

Our laboratories in Newark, N. J., offer ideal working conditions. We prefer that you have a degree in electrical engineering, physics, chemistry or mathematics—your experience, however, may be sufficient.

Why don't you find out whether there's a place for you with our fine staff of specialists. Write and tell us about yourself or Phone HUmboldt 2-5252, Ext. 72, for appointment.

NATIONAL UNION RADIO CORPORATION

50 Spring Street, Newark 2, N. J.



Wanted ENGINEERS

- Radio
- Chemical
- Electrical
- Electronic
- Mechanical
- Metallurgical
- Factory Planning
- Materials Handling
- Manufacturing Planning

Work in connection with the manufacture of a wide variety of new and advanced types of communications equipment and special electronic products.

Apply (or write), giving full qualifications, to:

C. R. L.
EMPLOYMENT DEPARTMENT

Western Electric Co.

100 CENTRAL AV., KEARNY, N. J.

Applicants must comply with WMC regulations

ELECTRONIC ENGINEERS

with some electrical or radio engineering experience.

INSTRUCTION BOOK ENGINEER

with electrical or radio engineering experience, plus a facile command of the English language.

FIELD SERVICE ENGINEERS

with thorough radio training, plus practical experience. Willing to locate anywhere in the United States, supervising the installation and maintenance of equipment.

The above positions offer good salaries, post-war opportunities, and interesting work in a good environment. Proof of citizenship and certificate of availability are necessary. Write, or apply to

SUBMARINE SIGNAL CO.
299 Atlantic Ave., Boston 9, Mass.

MECHANICAL DESIGNER:

Man having at least five years' experience designing small parts made on punch presses, screw and die casting machines for large quantity production. If not now employed at highest skill in war production plant, write:

P. R. MALLORY & CO., INC.
Indianapolis 6, Indiana

ANOTHER TUBE SUBSTITUTION

There is another side to the "easy tube replacement" stories so popular now, as is evidenced by this thinly-veiled protest just received from Mr. Vincent J. Lewis, Jr., of Lima, Peru:

The shortage of tubes for midget A.C.-D.C. receivers apparently presents a much more serious hazard to servicemen than it should. For it is a relatively simple matter to replace with any available tube, and compensate for the gain or loss in voltage by adding a resistor or two.

Take the case of the non-extant 35Z5 for instance. There are many tubes which will replace it if given a chance. In fact, any six volt triode connected as a diode with plate and grid tied together will serve admirably. It is simply necessary to add resistance in series and use the pilot lamp in parallel. Calculate the series resistor by subtraction thus: $35 - 6 = 29$. Therefore

$$E = 29; I = .15; \text{ then } R = \frac{E}{I} =$$

193 ohms.

But most six volt triodes draw .3 amps. It is obvious, therefore, that something must

be done to reduce this current. The tube filament, however, requires this .3 amp of current to operate properly so we simply add a bleeder across the other heaters to prevent its being drawn through them, too. The value of this resistor is, by Ohm's law (since this is a purely resistive circuit for

all practical purposes) $R_t = \frac{E_t}{I_t}$ and

$E_t = 117 - 35 = 82$ volts. $I_t = .15$ amps.

$$R_t = \frac{82}{.15} = 547 \text{ ohms.}$$

The power required is found by I^2R . .15 squared is .0225, and 547 times .0225 is 12.034 watts. (12R).

The wattage required for this resistor is therefore 12.034 or 13 watts. So . . . You are no further than you were at first what with high wattage resistors even harder to get than tubes. But you can still throw the set at the cat who is howling under your window. Even if you miss it will probably make a loud bang and scare the whole neighborhood. So, you see, your labor will not have been in vain.



ENGINEERS

Are You Concerned With YOUR POST WAR FUTURE ?

The Federal Telephone & Radio Corporation, the manufacturing unit of the International Telephone & Telegraph Corporation with its multiple business activities extending to all parts of the civilized world, will accept applications from experienced men for immediate employment with almost limitless post war possibilities. These positions should interest those with an eye to the future and whose interest lies in forging ahead with this internationally known organization whose expansion plans for post war are of great magnitude covering all types of radio & telephone communications. Advancement as rapid as ability warrants. Majority of positions are located in the New York area!

We need the following personnel! Men with long experience or recent graduates considered.

- ENGINEERS
- ELECTRONICS
- ELECTRICAL
- RADIO
- MECHANICAL
- CHEMICAL
- TRANSFORMER DESIGN
- SALES AND APPLICATION ENGINEERS
- PHYSICISTS
- DESIGNERS
- DRAFTSMEN
- TOOL DESIGNERS
- TECHNICAL WRITERS

Look Ahead With Federal!

If inconvenient to apply in person, write letter in full, detailing about yourself, education, experience, age, etc., to Personnel Manager.

FEDERAL TELEPHONE & RADIO CORP.

39 Central Avenue

EAST NEWARK

NEW JERSEY

FOR BATHROOM RADIO BARITONES

Radio-Craft has commented before on the Utility Radio Set for bathroom purposes. It is an established fact that most men, particularly executives and others, usually have not much time to listen to

radio except in the morning while they shave, and here a small radio set is ideal.

On the other hand, bathrooms are notoriously small and there is not much room in the average bathroom, particularly those in apartment houses. For this reason, a small radio set to which is attached a glass shelf on which bottles and toiletries, etc., may be placed, is often a distinct convenience.

The illustration shows a small radio of the pre-war type attached to the bathroom wall. On the top of the radio set there is a glass shelf which is clipped to it. The radio set has been waterproofed so moisture will not affect it. It has a pleasing appearance and should be an excellent item for radio manufacturers for the post-war period.

Crystals for use in transmitters of the armed forces are so important that ordinary methods of shipment are inadequate for delivery. John Meck Industries, of Plymouth, Indiana, have therefore bought a fast plane to speed up their delivery schedule.

The plane is a flivver Monocoupe, powered by a 125-horsepower engine. It is piloted by some of the boys in the Meck plant, and occasionally by one of the several excellent local women skippers.



RADIO-CRAFT for JULY, 1944

DEVELOPMENT ENGINEERS

Mechanical and electrical. Graduate or equivalent training. Required for development work in the following branches:

1. Electro-mechanical devices, communication systems. Must be interested in development and familiar with magnetic circuits.
2. Measuring and control instruments. Background should be in electrical engineering, including electronics.

Statement of Availability Required.

BOX 702 c/o Radio-Craft
25 West Broadway, New York 7, N. Y.

DESIGNER

A central New England manufacturer employing over 1000 people needs Draftsman-Designer on telephone and signaling (mechanical) apparatus.

Knowledge of die-casting and plastic applications desirable.

WMC Regulations Prevail

BOX 704

c/o Radio-Craft

25 West Broadway, New York 7, N. Y.

X-RAYS AND SHELLS

PHOTOGRAPHY is assuming an increasingly important role in the production of explosives, by the Ordnance Department, Army Service Forces.

Until recently, for example, it was impossible to obtain X-ray photographs of big 155-mm. high explosive shells. The steel casing of each shell varies from one to three inches and contains a solid mass of TNT which varies in thickness from two to five inches.

A unique million-volt X-ray machine was designed to meet this unusual problem. Today it is possible for a number of shells on a revolving belt or line to be X-ray photographed at the same time. The slightest crack in the shell or the smallest cavity in the load is instantly detected. These defects, if undiscovered, might destroy both the gun and crew.

The old hand-method of examining sample high explosive shells was slow and difficult. Ordnance officers estimate that the new X-ray machine will permit the examination of from three to five thousand shells a day and will pay for itself in a year in the saving of labor and material.

The camera is also used to register such vital data as the size, intensity and location of powder flashes, or the progressive ignition of explosive charges. Ordnance technicians use such information to improve artillery projectiles, propellants, flares, rockets, and photoflash bombs.

Ordnance chemists investigating powder structures require spectrographic and micro-photographic film records. They photograph the color of the signal rockets, flame temperatures, sizes of particles, and the varying hues assumed by powder under all conditions encountered on the battlefronts.

New Direct-Coupled FM - AM AMPLIFIER MANUAL

By **A. C. SHANEY**
Chief Engineer, Amplifier Co. of America

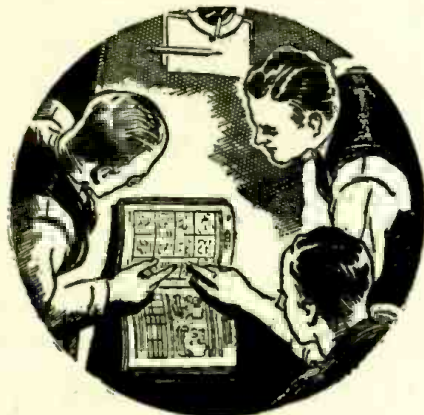

For the Layman, Serviceman
Recordist and Engineer

Regardless of whether you are interested in the finest type of phonograph reproduction, high fidelity recording, sound-on-film applications, FM or AM programs, you will find invaluable information in this practical handbook. Written by the leading exponent of direct-coupled amplifiers who has spent more than 10 years improving and perfecting the famous Loftin-White circuit.

Explains the theory and practical application of:

- Variable Speed Non-Overloading Push-Pull Expansion
- Non-Frequency Discriminating Scratch Suppression
- Push-Pull Balanced Direct-Coupled Amplification
- Push-Pull High-Frequency Equalization
- Push-Pull Low-Frequency Equalization
- Push-Pull Volume Compression
- Automatic Volume Limitation
- Automatic Volume Control
- Calibrated V. U. Indicator
- Audio Spectrum Control
- Remote Control

If you are interested in the latest audio developments, you can't afford to be without this complete compilation of authentic articles on Direct-Coupled Amplifiers. 32 pages 8 1/2" x 11". Over 100 diagrams and illustrations.

Priced to Cover Cost of Printing and Mailing **25c**

Send U. S. Stamps or Coin

AMPLIFIER CO. of AMERICA
396 BROADWAY NEW YORK, N. Y.

Radio AND ELECTRONIC DEVICES

BURSTEIN-APPLEBEE CO.
1012-1014 McGee St. • Kansas City 6, Missouri

Blind radio workers trained under the auspices of the Board of Education, New York City, are so successful in their jobs that concerns are reported in virtual competition with each other for the successful graduates of the training course.

Seventy former students now employed in jobs that require a high sense of touch are now earning as much as 76 cents per hour. Spurred by their success, many others are now attending the classes in radio and electrical communications.

A new ceramic coating containing silver powder may be used to make surfaces conductive. The product, developed by DuPont, can be applied by spraying, dipping or brushing, and be either air-dried or baked.

TECHNOTES

... THREE-WAY PORTABLE JOBS

There are many three-way portable sets in use today. These can be a pain in the neck to servicemen because of their habit of cutting off and intermittent operation. The following hints should be useful.

Many of these sets cause trouble because of low filament voltage. Diagram shows a typical circuit of this kind. Typical tubes are shown, but they may be of other types, especially the rectifier which may also be of a lower voltage type with suitable connections.

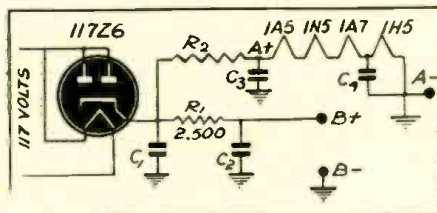

A choke coil sometimes takes the place of the resistor R1. C1 and C2 are usually electrolytics of between 20 and 50 MFD, and C3 usually 100 MFD. The latter may be of smaller value when a choke is used. C4 is a by-pass from filament oscillator-converter to ground. R2 may be calculated from Ohm's law. If the filaments drop totals 6 volts at .050 amps as in the figure, across R2 there must appear 110-6 or 104 volts at .05 amperes. It should be 2080 ohms.

If with the use of a proper resistance as shown we are still unable to measure about 1.4 volts across each filament (with a high resistance or vacuum-tube voltmeter), note that C3 may have an effect upon this voltage. Replace with a known good one of the correct value. C1 or C2 occasionally affect the voltage, also. The usual trouble is, of course, low emission from the rectifier, which should be checked first.

The by-pass C4 may also be causing trouble. If it has a resistance as low as 50 megohms, the leakage may affect the circuit.

The oscillator-mixer sometimes checks good in a tester but still refuses to oscillate. Make sure of this tube by trying another known to be good.

The above troubles are different than those found when servicing other types of sets and should be checked for when a three-way portable comes back to your shop.

JOHN CANNON,
Jackson, Miss.

... OSCILLATIONS IN I.F. STAGES

These are noticeable in small late model A.C.-D.C. radios having loop antennas in back cover. Very often it is found after aligning one of them that it has an annoying tendency to oscillate or hover just on the edge of oscillation causing poor tone and critical tuning.

The trouble can be corrected by placing a small square of metal against the top of each I.F. transformer. Drill a hole in the center of each square and use the nut on the top of the transformer to hold it on. The squares may be cut from any scrap sheet metal. They cover the two holes through which adjustments are made. The nearness of the loop apparently causes feedback through these holes.

Have used this simple trick for some time and it works out fine.

NESSLER RADIO SERVICE,
Dubuque, Iowa.

... CANADIAN STEWART WARNER NO. 416

Six out of eight of the above model were found to be intermittent or dead because of opening and closing of the shorter winding on the oscillator coil.

Close examination of the coil will sometimes reveal the defect. It should be rewound with eight turns of the same size wire. Coil form should be sized or shel-lacked before and after winding, and this trouble will not occur again.

O. R. THOMPSON,
Oxford, Nova Scotia.

... CANADIAN MAJESTIC MODEL 10 MA514

I replaced the 12A8M converter with a 6D8GT. The total original voltage was 121, so that the new lineup totalled 115 volts, making an additional resistor unnecessary. It is only necessary that the additional space be available in the cabinet.

Some sets may require a series resistor of about 40 ohms to take care of the extra 6 volts. Both tubes take .15 amps.

C. W. MURRAY,
Halifax, N. S.

... PACKARD BELL MODEL B 19

Cutter chatter when set is on "mike-rec-ord" with no pickup at mike. Replace filter condensers with larger values. Also check 12,000 resistor in switching circuit for short or reduced value.

WILLIAM PORTER,
Los Angeles, Calif.

POST-WAR USES FOR HANDIE-TALKIES

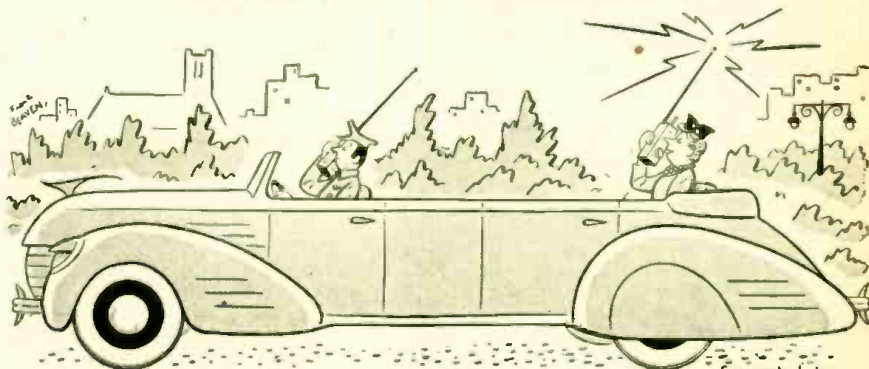

"Home, James."

Suggested by:
ALBERT SHRAGER,
Philadelphia, Pa.

FOR SALE HARD-TO-GET ITEMS

All items are brand new, except where indicated. All are in PERFECT WORKING ORDER. In many cases, the parts alone total more than the price we are asking. Satisfaction guaranteed or your money back. ORDER FROM THIS PAGE. Use our convenient coupon. Include sufficient extra remittance for parcel post charges, otherwise order is sent express collect. Any excess will be refunded. All C.O.D. shipments require 20% deposit. No C.O.D. shipments on orders for less than \$5.00. If full remittance accompanies order deduct 2% discount. Send money order, certified check, or new U. S. stamps. No C. O. D.'s to foreign countries.

THE MAGIC ELECTRIC WELDER



Here is one of the most compact, practical welders we have ever seen. Anyone can use it for shop, farm and home repair. It is a D.C. BRAZES, SOLDERES, CUTS ALL METALS. ANYONE CAN OPERATE IT. Repairs steel, cast iron, aluminum, brass, copper, bronze, etc. Complete with power unit, d.c. and metallic arc attachments. (Really two welders in one). Carbons, fluxes, rods, mask included. Dual plug for any electric outlet. 110 volts AC or DC. For hobbyist or professionals.

GET IN ON THE GREAT WELDING BOOM. This set quickly teaches you welding. Low cost to operate—about 6c an hour. COMPLETE SAFETY is assured. No fumes with this outfit. SET COMES COMPLETE—nothing else to buy. Used by the U. S. Navy, American Tel. & Teleg. Co.; Eastman Kodak Co. Built in Laboratories, etc. BRAND NEW OUTFIT. Guaranteed for one year. Complete simple instructions with each set. ITEM NO. 188 YOUR PRICE \$19.95

WESTERN ELECTRIC BREAST MIKE

This is a fine light-weight aircraft carbon microphone. It weighs only 1 lb.

Mike comes with breastplate mounting and has 2-way swiveling adjustment so that it can be adjusted to any desired position. There are 2 woven straps: one goes around neck, the other around chest. Straps can be snapped on and off quickly by an ingenious arrangement.

This excellent mike can be adapted for home broadcasting or private communication systems. By dismantling breastplate, it can be used as desk mike.

Comes complete with 6-foot cord and hard rubber plug. Finished in sandblasted plate, non-rustable.

THIS IS A BRAND NEW MIKE. IT HAS NEVER BEEN SOLD AT SUCH A LOW PRICE BEFORE. ORIGINAL LIST PRICE \$15.00. Shipping weight 2 lbs.

ITEM NO. 152 YOUR PRICE \$2.55

POWERFUL ALL-PURPOSE INDUCTION MOTOR

IDEAL FOR EXPERIMENTERS—101 USES



Sturdily constructed to precision standards, this self-starting shaded pole A.C. induction motor is powerful enough for a number of uses. Some of these are: Automatic Timing Devices, Current Interupters, Electric Fans, Electric Chimes, Window Displays, Photo-cell Control Devices, Electric Vibrators, Small Grinders, Buffers and Polishers, Miniature Pumps, Mechanical Models, Sirens, and other applications.

Consumes about 15 watts of power and has a speed of 3,000 r.p.m. When geared down, this sturdy unit will constantly operate an 18-inch turntable loaded with 200 lbs. dead weight—THAT'S POWER!

Dimensions 3" high by 2" wide by 1 3/4" deep; has a convenient mounting stud; shaft is 1/8" long by 3/16" diameter and runs in self-aligning oil-retaining bearings. Designed for 110-220 volts, 50/60 cycles, A.C. only.

ITEM NO. 147 YOUR PRICE \$1.95

LIMITED QUANTITIES! PROMPT SHIPMENTS!

It's Easy to order—Clip Coupon—Order from This Page—No Catalog Sent.

(See Corresponding Ad. Page 629)

MAIL TODAY—NOW!

HUDSON SPECIALTIES CO.

40 West Broadway, Dept. RC-7-44, New York 7, N. Y.

I have circled below the number of the items I'm ordering. My full remittance of \$ (include shipping charges) is enclosed. (NO C.O.D. ORDERS UNLESS ACCOMPANIED WITH A DEPOSIT.)

OR my deposit of \$ (is enclosed (20% required), ship order C.O.D. for balance. NO C.O.D. ORDER FOR LESS THAN \$5.00. (New U. S. stamps, check or money order accepted.)

Circle Item No. wanted 147 152 188

Name

Address Please Print Clearly

City State

Send remittance by check, stamps or money order; register letter if you send cash or stamps.

MEASURING CAPACITY

(Continued from page 603)

volts on the meter. It is possible that the meter is really calibrated as a milliammeter rather than as a voltmeter but this makes no difference. If full-scale is read on applying 100 volts A.C., then 80 volts would mean 4/5 full-scale, etc.

Following Fig. 9, we therefore draw the line Ed equal to 80 units (2"). The remaining line Ec is then measured. In this case it comes out to 1 1/2" or 60 units. The solution is found from the formula

$$C = \frac{377 E_c R_M}{10^9 E_d}$$

where C is in microfarads and R_M is the total circuit resistance, such as R_M in Figs. 8-a and 8-c, and R_M/10 in Figs. 8-b and 8-d. Therefore, on the scale corresponding to 80 volts, we would mark

$$10^9 \times 80$$

off a capacitance equal to $\frac{377 \times 60 \times R_M}{10^9 \times 80}$

This formula applies to 60 cycles only. Assuming that we now have an A.C. voltmeter arranged to read full-scale with no condenser in series with it (Fig. 6), let us discuss means for designing multiplying factors. For convenience, these factors may be 10, 100, etc.

Looking at Fig. 8-a, we may note that a definite reading will be obtained when the unknown C is placed in series with the voltmeter. Now we shunt the meter itself with R_{sh} equal to 1/9 the meter resistance and add a series resistor R_s sufficient to cause the meter to read full-scale when XX is shorted. The scale is now a "×10" scale, all indications being ten times as large as previously. Notice that ten times the current is now flowing in the circuit.

Another multiplying method involves a decrease in the voltage source (Fig. 8-c and 8-d). To multiply all indications by 10 it is necessary to reduce the voltage source to one-tenth. The series resistor R is then reduced until we again obtain full-scale reading when XX is shorted. In both methods the multiplying range shows a total circuit resistance one-tenth the original range.

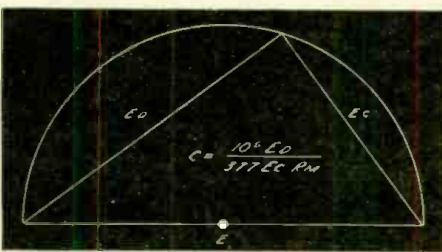

Fig. 9—Meters may be calibrated without recourse to cut-and-try, using the chart above.

Evidently, the first method may be carried out so as to provide any multiplying factor we desire so long as sufficient current is available, while the second method assumes that the series resistor actually can be reduced to the desired value.

Instruments for all the above measuring methods are easily set up and require only a meter of a type usually available. After constructing such a unit, the designer will find almost as much use for it as he does for his ohmmeter.

Radio telephone service is now open between the United States and Trinidad, the most southerly island of the West Indies; it is handled through short-wave telephone facilities at Miami, Fla.

HARCO

RADIO MASTS and TOWERS

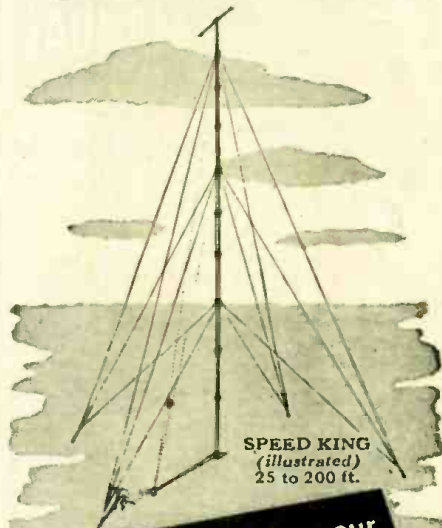

are the solution to your PROBLEMS (present or post-war)

because—

1. LOW TRANSPORTATION COST.
Shipping expense reduced to a minimum because total weight and shipping space is extremely small. Also low storage and handling costs.

2. MINIMUM ERECTION COST.
Speedy erection insured—due to elimination of bolts and because customary erection labor expense has been reduced by shop fabrication. All connections reduced to simplest form.

3. CAN BE ERECTED WITH INEXPERIENCED LABOR.
HARCO MASTS AND TOWERS are easy to put up. Emphasis placed on portability—no sections are too heavy for one man. No skill required for making connections. None of the usual hazards exist. Ground assembly optional.

4. CAN BE ERECTED UNDER ADVERSE CONDITIONS.
Erection accomplished under all weather conditions and extreme temperatures by men wearing gloves. Rigid construction is the result of all sections having a high strength-weight ratio, and the type of connections and bracing used. Every safety precaution possible has been taken.

Whatever your problems may be, HARCO can solve them from every Engineering angle. If none of our 16 Standard Designs meet your requirements, we can give you a "Custom Built" job.

Please send complete design specifications when inquiring for detailed information.

HARCO

STEEL CONSTRUCTION CO., Inc.
Elizabeth 4, New Jersey

ELECTRICIANS! RADIO MEN!

Earn More Money!

Get this new
GIANT SIZE

**ELECTRICAL
and RADIO
TROUBLE
SHOOTING
MANUAL**
GUARANTEED BY
COYNE

Yours 5 Days Free

Needed by war workers, maintenance men, beginners, old timers! Nothing else like it. Saves time, helps boost your pay. ... 4 GREAT BOOKS IN ONE!

1. New Step-by-Step Trouble Shooting Course. 2. 500 Shop Prints. 3. Electrical Dictionary. 4. Spare Time Jobs.

FREE! 1 yr. Technical Counsel by mail from COYNE staff, on trouble-shooting problems.

SEND NO MONEY! See offer below.

Satisfaction guaranteed by famous COYNE "Learn-by-Doing" Electrical School. Rush coupon now!

**OVER
500**
Large Size
Electrical and
Radio
Shop Prints
-How to read
and use them

H. C. LEWIS, Pres., Dept. B4-M8
COYNE ELECTRICAL SCHOOL
500 S. Paulina St., Chicago 12, Ill.
Send, with all shipping charges paid, your new COYNE Electrical and Radio Trouble Shooting Manual. Within 5 days after getting it I'll either return it or send \$3, then \$3 monthly until total of \$9.90 is paid. 1. Cash price \$9.90—You save over 40%. Same 5-day \$3.00 trial and return privilege.

**FREE TRIAL
COUPON**

NAME _____
ADDRESS _____
CITY _____ STATE _____

Inventions Wanted Patented or Unpatented

We have been successfully selling inventions, patented and unpatented, since 1924. Write us, if you have a practical, useful idea for sale.

**CHARTERED INSTITUTE
of AMERICAN INVENTORS**

Dept. 111, 631 Pa. Ave., N.W., Washington, D.C.

RADIO AND ELECTRONICS BOOKS

Immediate Shipment on Mail Orders Anywhere. We stock nearly all radio and electronics books, and can furnish any other currently published one on short notice. Send stamp for catalog. Currently popular books include:

"Practical Radio Communication," Nilson.....	\$6.00*
"Principles of Radio," Henney.....	3.50*
"Mathematics for Radiomen," Cooke.....	4.00*
"Radio Physics Course," Ghrardl.....	5.00*
"Radio Engineering Handbook," Henney.....	5.00*
"Radio Engineers' Handbook," Terman.....	6.00*
"Theory and Appl. of Vacuum Tubes," Reich.....	5.00*
"Electronics," Millman and Seeley.....	5.00*
"Radio Engineering," Terman.....	5.50*
"Microwave Transmission," Slater.....	3.50*
"Cathode-Ray Tube at Work," Rider.....	3.00*
"Frequency Modulation," Rider.....	1.50*
"Radio Manual," Sterling.....	6.00*
"Measurements in Radio Engineering," Terman.....	4.00*
"U.H.F. Techniques," 4 authors.....	4.50*

*Add 4% for domestic postage (including A.P.O.'s); foreign, 10% by Calif. add 2% sales tax.

EDITORS AND ENGINEERS

1424 North Highland Ave., Los Angeles 28, Calif.

\$3.00 FOR YOUR IDEA

RADIO-CRAFT, as you will have noticed, prints a number of radio cartoons, which we intend to keep on publishing every month indefinitely. We invite our readers to contribute to this feature by sending in their ideas of humorous radio ideas which can be used in cartoon form. It is not necessary that you draw a sketch, but you may do so if you so desire.

RADIO-CRAFT will pay \$3.00 for each original idea submitted and accepted.

We cannot return ideas to this department nor can we enter into correspondence in connection with them. Checks are payable on acceptance.

Address all entries to RADIO CARTOONS, c/o RADIO-CRAFT, 25 West Broadway, New York 7, N. Y.

The Mail Bag

WHY SCREW-DRIVER EXPERTS ARE UNPOPULAR

Dear Editor:

The Serviceman's main headache has long been the newcomer with his "Free Service Call" to get the customers. Usually his sets are not properly repaired and when the set finally gets into a good shop it is necessary to spend an extra half-day tracing circuits to get the wiring back to where it was before. The cost is sometimes so great that the customer says he would rather throw the set away and get a new radio.

The worst feature is that the same customer has lost most of his confidence in repair men and is more than a little doubtful that any of them can fix his set right.

If licensing servicemen like electricians and plumbers would cure that headache, it would do more than any other one thing to raise the status of the profession.

I also agree with Mr. Embree on the 90-day guarantee. I always made it a practice to guarantee my work though I also ran into the old trouble of the customer who couldn't understand why a guarantee on a new output transformer didn't include the antenna coil or a couple of tubes, if they happened to burn out soon after the repair.

WALTER L. HAUSE,
Albuquerque, N. M.

THIS READER LIKES DIAGRAMS AND KINKS

Dear Editor:

To the best of my knowledge, *Radio-Craft* holds front line in radio and electronic publications since 1929.

Your full sheet Diagrams and Kinks, also instrument building articles and latest discoveries in the world of radio, are especially appreciated.

Before the war, as an example, I had a young serviceman who wanted all my magazines which I read. Before he left for the army, he gave me about 260 full page

diagrams of different radio sets, which he cut out from *Radio-Craft* and said: "I received half of my education from this Manual, and now I pass them on to you."

Since radio tubes are scarce and business slack, we do appliance and instrument repairing, and hope to give the boys a chance at the business when they come back from over there.

W. F. ONDER,
Kinmswich, Mo.

PATRONS OF TINKERERS NOT GOOD CUSTOMERS

Dear Editor:

The idea of getting radio parts at a discount for servicemen only sounds good from the Serviceman's viewpoint but, like the saying about the grapefruit, there is more to it than meets the eye. How about the thousands of amateurs, experimenters and builders who use radio as a hobby? Many of them are in their teens, and must carefully consider every dollar spent for equipment and parts. Why would you boost prices to list and have the wholesaler pocket the extra 25% to 40%?

I doubt that a good serviceman suffers greatly from the inroads of the "screw driver" repairman. Also, there are far too many servicemen in the screw-driver class, and I believe that a little self-improvement would not be out of order. Those customers who patronize a "cheap" serviceman to save a dollar or two do not make up the ideal trade for a reputable serviceman.

HENRY VAN ZUYER,
Hanford, Calif.

A FEW BEYOND-THE-ULTIMATE THEORIES

I have been in the radio servicing business since the middle "20's" and have found your magazine very helpful. I am now serving with the U. S. Navy but still enjoy the paper.

Your current editorial on "Magnetic Currents" in *Radio-Craft* interested me very much. It is encouraging to see at least one "Grey Beard" take a slight interest in the fundamentals of an electric current. When the electron theory was advanced it seemed to fill most of the requirements so no one has bothered much until now to really discover anything about an electric current.

In a few more years it will be discovered that all currents are magnetic. There is no such thing as an electric current anyway. I have had my own theory for over 12 years and am glad at last to see someone bearing it out. If you yourself would only pause and think *seriously* about an electric current you would realize there could be no such thing as an Electron or Proton. Start with a generator and think carefully of its method of operation and you will realize that the effect is purely magnetic.

Now that gives you the proper starting point so just forget your electron theory and think of the electron as if it were the earth with a north and south pole.

Next month I am sure you will be able to publish the first of a series of articles on what electricity really is. If you need additional clues I will be glad to send them but I prefer to help guide you into the proper channel and let you reason it out for yourself.

With your knowledge you only need to forget the present concepts for an hour or so and use your actual knowledge of the effects of current.

WILLIAM EARL SKELTON, SR. RT2/C,
Chicago, Ill.

(The above is interesting, but we do not intend to give up our belief in electric currents during the next week or two. Even Dr. Ehrenhaft did not go as far as our correspondent, in that he points out that a magnetic current is surrounded by an electric field in the same manner that an electric current is surrounded by a field of magnetism.—Editor)

A tube manual will give all the information necessary. The set under test should be turned on and the ground lead of the tracer clipped to the chassis. The R.F. and I.F. lead is then plugged in the Signal Tracer and the selector switch, in the lower left hand corner of the panel, is moved to No. 1 position. The R.F. and I.F. probe is applied to the antenna and signals should be heard if the antenna primary coil is O.K. The probe is then placed on the control grid of the R.F. tube and a signal tuned in with the variable condenser gang of the receiver. By placing the probe on this tube's plate the signal should become much louder, indicating gain in the stage. The grid of the mixer stage is checked next and a signal should be heard; if this is normal the probe is placed at the mixer plate, which should show increased signal strength. We next place the probe on the I.F. grid. If normal signal is received, then move the probe to the plate prong of the same tube, to compare the respective signal strength and thus check whether the signal is being amplified in that tube. If the set is working properly, the signal will increase in volume and should be reduced by the Signal Tracer volume control. The diodes of the second detector are the last test point for the R.F. and I.F. probe. It can be easily understood from the foregoing that it is only necessary to place the probe on the grid or plate of the R.F. or I.F. amplifier to find the signal. If the signal does not appear at the above points the trouble is just before the point where the signal disappears.

CHECKING OSCILLATORS

To check the oscillator place the probe on the oscillator grid. This should close the "eye," giving an indication that the oscillator is functioning. If the "eye" remains open the oscillator is not working properly. To check the audio system the A.F. probe is used and the selector switch moved to the low audio position. The probe is placed on the grid of the first audio tube and the signal followed through from grid to plate up to the voice coil of the speaker. The trouble is where the signal stops. If the signal level is too high, switch to the other audio position which cuts one audio stage out of the circuit.

To check a.v.c. action turn the selector to the correct position and place the A.F. probe anywhere on the a.v.c. but, then by tuning in a station on the set the "eye" will give an indication of the a.v.c. action. The "eye" is adjusted with the 10,000 ohm control. The "eye" may also be used for alignment purposes, by placing the probe on the diode prongs and adjusting the various I.F. and R.F. trimmers for maximum deflection.

A QUICK TEST METHOD

We may check the entire R.F. and I.F. part of a receiver in one operation by placing the selector switch in the correct position and applying the probe to the diodes. If a loud signal can be tuned in without distortion we may assume that this part of the set is working properly. To check the audio section of a set the multiplier switch (No. 1), which is directly above the selector switch, is moved to No. 5 position—which cuts in the antenna coil and tuning condensers—and the selector switch moved to the high audio position. A station is then tuned in on the Signal Tracer and this signal applied to the grid of the first audio tube with the A.F. probe. If the audio system is operating in a normal manner, a loud signal should be heard in the set's speaker.

The speaker in the Signal Tracer should be cut out by the speaker switch so that if any distortion is present it may be recognized as coming from the receiver.

TRACING THE INTERMITTENT

Intermittents are located by placing the R.F. and I.F. probe on the diode prongs and turning the selector switch to No. 1 position. A station is tuned in on the set and the Signal Tracer's speaker switched off. When the set stops playing the Signal Tracer's speaker is switched on and if a signal is heard the trouble is in the set's audio system. If no signal is heard the trouble must be in the R.F. or I.F. part of the set. By using the methods previously outlined the trouble may be quickly tracked down. When testing for noise, motorboating or hum, use the probe to test the screen-grids, suppressor-grids and cathodes along with the grid and plate of the tubes. The power supply is checked for excessive hum with the A.F. probe. Start at the rectifier filament or cathode and apply the probe to the choke and various filter condenser connections until the fault is located. Hum is quite loud at the rectifier but should be greatly diminished at the last filter condenser connection.

Gain per stage may be roughly determined by ear or by using the multiplier switch to cut in the attenuating condensers when using the R.F. and I.F. probe.

TUBES AND MICROPHONES

In checking tubes the probes are used in the usual manner. There should be a very definite gain between the grid and plate of the various tubes. If very little or no gain is obtained the voltages to the tube terminals should be checked. If these are normal the tube should be replaced. The A.F. probe is used to check push-pull or phase inverter circuits. The signal should be of equal strength at the grids of the output tubes. If it is not, move the probe backward from grid to plate until the trouble is located.

Crystal microphones and pickups are easily checked with the selector switch in the low audio position and the A.F. probe. The ground wire of the Signal Tracer should be clipped to one of the leads of the "mike" or pickup.

Carbon "mikes" and low impedance pickups are checked in the same manner except that a suitable transformer must be used between them and the A.F. probe.

By using a record player attached to the input of a set's audio amplifier or to the input of a public address system, the point where distortion or overload occurs may be determined in the usual manner, from grid to plate, with the A.F. probe. It may be necessary to use the high audio position on the selector switch because the Signal Tracer will overload at certain points. A record player gives a much better indication of distortion than an audio signal generator. If the serviceman finds it necessary, a R.F. signal may be fed from the Signal Tracer through the R.F. probe to the R.F. portion of the set being tested.

This Signal Tracer makes an excellent record amplifier and may be used as a small public address system. Used as a radio it is not selective but gives satisfactory results on local stations. As the serviceman acquires facility in the use of this instrument many more uses will suggest themselves and he will find servicing more speedy and profitable.

Learn RADIO-ELECTRONICS

12 WEEKS TRAINING IN COYNE SHOPS ON REAL RADIO - ELECTRONIC EQUIPMENT! FOR MEN 16 UP TO 50



Prepare for a great Peace time future *H.C. Lewis* and a good job in Radio and Electronics now. Coyne "LEARN BY DOING" training covers latest developments in this field. Prepare quickly, easily. Fascinating well paid work in maintenance, installation and servicing Radio and Electronic equipment.

I'LL FINANCE YOUR TRAINING!

Start now—pay tuition after graduation. My plan has helped thousands. I assist you in getting part-time work while at COYNE to help pay living expenses. Job Service when trained. Also have facilities for men with physical disabilities. Write

ELECTRONICS AND TELEVISION

Tremendous expansion in Radio, Electronics, Frequency Modulation and Television predicted after the war—a world of new opportunities. Get ready for a Peace time future and a good job NOW with practical Coyne Radio Training.

FREE BOOK! Whether you're 16 or up to 50 get facts. Special Industrial Electronics training included at no extra cost now. Mail coupon today.

H.C. LEWIS, Pres., RADIO DIV., COYNE ELEC. SCHOOL, 500 S. Paulina St., Dept. 84-8H, Chicago 12, Illinois

Send me FREE BOOK, "Your Future in Radio", and details of Industrial Electronics training included at no extra charge and easy "Pay-After-Graduation" plan.

NAME..... AGE.....
ADDRESS.....
CITY..... STATE.....

Prepare to get your "ticket"!

HOW TO PASS RADIO LICENSE EXAMINATIONS

By Charles E. Drew,

I.R.E., A.I.E.D.



Here's the quickest, surest way to get the information you must have in order to win that important "ticket." Revised and brought right up to the minute, it covers every field of radio communication—

transmission or reception—whether in marine, aeronautical, police, or broadcasting.

In easy-to-follow question-and-answer form, it explains Basic Radio Laws; Basic Theory and Practice; Radiotelephone; Advanced Radiotelephone; Radiotelegraph; Advanced Radiotelegraphy.

The "Bible" of the Radio Field!

Send for YOUR Copy Today
Second Edition 320 Pages \$3.00

On Approval Coupon

JOHN WILEY & SONS, Inc.
440 Fourth Avenue, New York 16, N. Y.
Please send me on ten days' approval a copy of Drew's HOW TO PASS RADIO LICENSE EXAMINATIONS. At the end of that time, if I decide to keep the book, I will remit \$3.00 plus postage; otherwise I will return the book postpaid.
Name.....
Address.....
City and State.....
Employed by.....

RC-7-44

USED Correspondence Courses Complete HOME-STUDY Courses and self-instruction books, slightly used. Rented, sold, exchanged. All subjects. Satisfaction guaranteed. Cash paid for used courses. Full details 8 1/2" (used) illustrated bargain catalog Free. Write now. NELSON CO., 321 S. Wabash Av., Dept. 2-39, Chicago 4, Ill.



Our Headphones are used by the United States, Canadian, New Zealand and South African Governments as well as other Governments not directly in the war.

Headset Headquarters

Scientifically built heavy bar magnets greatly increase their efficiency.

Folder R-7 illustrates rugged, unusually sensitive, dependable Cannon-Ball Headsets.

Write

C. F. CANNON COMPANY
SPRINGWATER, N. Y.

LEARN ABOUT THE GREAT POST-WAR FIELD

ELECTRONICS!

BRAND-NEW!
PRACTICAL! SIMPLIFIED!



JUST OFF THE PRESS!
Brandnew! Practical! Simplified. THE quick, easy way to get a knowledge of **ELECTRONICS IN INDUSTRY** — greatest of all Victory opportunities.

Big new 400 page manual tells how to do Electronic work. Handy for home learning and job use — full of easy-to-follow diagrams. For beginner or old timer. Guaranteed by Coyne. Send coupon TODAY!

FREE with Manual!
1 yr. Personal Counselor by mail on your Electronic Problems from Coyne staff. ALSO FREE — 1 year subscription to Coyne Technical News.



H. C. LEWIS, Pres.,
COYNE ELECTRICAL SCHOOL
Dept. 44-8, 500 S. Paulina St., Chicago 12, Ill.
Send me postpaid your big new manual, **ELECTRONICS IN INDUSTRY**. I enclose \$4.95. I understand that I can return book within 5 days and get my money back if not satisfied.

NAME.....
ADDRESS.....
CITY.....STATE.....
 If you wish we will send it C.O.D. Same return privileges if not satisfied — check here for C.O.D.



HIGH EFFICIENCY results in *Some National Defense* that is why **NATIONAL DEFENSE SOUND SYSTEMS** are equipped with *University Reflex* HIGH POWER LOUDSPEAKERS **UNIVERSITY LABS.** 225 VARICK ST. N.Y.C.

OPPORTUNITY AD-LETS

Advertisements in this section cost 20 cents a word for each insertion. Name, address and initials must be included at the above rate. Cash should accompany all classified advertisements unless placed by an accredited advertising agency. No advertisement for less than ten words accepted. Ten percent discount six issues. Twenty percent for twelve issues. Objectionable or misleading advertisements not accepted. Advertisements for August, 1944, issue must reach us not later than June 28, 1944.

Radio-Craft • 25 W. B'way • New York 7, N. Y.

USED CORRESPONDENCE COURSES AND TECHNICAL Books Bought, Sold, Rented, Catalog Free. Educational Exchange, Henagar, Alabama.

PREPARE NOW FOR TREMENDOUS OPPORTUNITIES in new fields of radio after the war. Training for Federal licenses. Write for particulars. American Radio Institute, 44 East 23rd Street, New York 10, N. Y.

SELENIUM RECTIFIERS. FULL WAVE 50 VOLTS maximum load. 2 1/2 amperes \$3.49 2 pounds. 115 volt transformers secondary 30 volts 3 amperes \$2.29 8 pounds. 11st free. Milton Bursma, 105 Aroindale, Jackson, Mich.

200 TUBE SUBSTITUTIONS 12SA7, 50L6GT, 35Z5GT, etc. Instructions \$1.00. Richard Jones, 1210 Dudley, Utica 3, N. Y.

YOUR POST-WAR RADIO

(Continued from page 585)

conscious. Even before Pearl Harbor, the wave of records had reached an all-high point. That wave has not abated. Indeed, more phonograph records are sold now than ever before. Many of these records are played on ordinary phonographs, but the majority are used in radio-phonograph combinations. Therefore, it would appear that one of the "must" features of the post-war radio would have to be radio-phonograph operation. Whether it will use a pickup, as we know it now, or whether a totally different means will be evolved is unforeseeable. I do believe, however, that there will be a revolution in this connection, and that we will have something much more simplified than the pre-war pickup with its cumbersome mechanical features.

It is almost a certainty that your post-war radio will be adaptable to FM. Most likely it will be a combination AM-FM.

As to television, if present indications and trends mean anything, it would seem that your post-war radio must also include television reception. It is quite true that for several years after peace has been declared, there will be no television transmitters in many parts of the country. Nevertheless, radio sets will have to be made as combination phonograph AM-FM plus television. The man who wishes to buy the latest radio set wants it to have everything and that must include television. The television angle, however, is also one still fraught with difficulties.

As I have mentioned innumerable times in these pages, television will never be a success until radio sets with video reception equipment can be manufactured at a reasonable cost. Therefore, if your post-war radio, television equipped, cannot be bought around \$100.00 or less, television will be destined again to fail as it has in the past, chiefly because of the very high cost of such sets. If your post-war radio receiver, equipped with every new improvement, can retail between \$60.00 and \$85.00, then I will admit that the television age is here for good—but not before.

The thing that stands in the way of mass-producing television receiver sets is chiefly the high cost of cathode-ray tubes. It appears that the bare glass tube from which cathode-ray tubes are made, costs the tube manufacturer the tremendous amount of \$4.00, just for the glass alone. This immediately knocks out mass production of cathode-ray tubes, at least for the present. Until these tubes can be produced to retail for a price of \$2.00 tops, there cannot be any thought of television reception in every home in America.

No doubt the economics of cathode-ray tube manufacture will be solved in due time. Perhaps we will have all-metal cathode-ray tubes; or they might be made out of special plastics. These are not impossibilities, but so far these developments are not in sight. The problem, however, may be solved by the time the war has drawn to a conclusion—at least let us hope so, because then you may for a certainty have television added to your post-war radio.

Radio control as an experiment received very favorable comment after recent tests on the Denver & Rio Grande Western Railway. A 70-car Diesel-powered freight was equipped with front-to-rear communication, one transmitter-receiver being installed in the cab and one in the caboose.

Index to advertisers

Aerovox Corporation	628
Allied Radio Corp.	629
Amplifier Company of America	634
Audel & Company	Back cover
Browning Laboratories, Inc.	Inside back cover
Burstein-Applebee	634
Cannon Company, C. F.	638
Chartered Institute of American Inventors	636
Chicago Novelty Co., Inc.	625
Coyne Electrical School	636, 637, 638
DeForest's Training, Inc.	631
Echophone	611
Editors and Engineers	636
Federal Telephone & Telegraph	633
General Electric Co.	619
Hallicrafters, Inc.	579, 580
Harco Steel Construction Co.	635
Harrison Radio	623
Henry Radio	621
Hudson Specialties	629, 635
Lafayette Radio Corp.	630
Lancaster, Allwine & Rommel	627
Mallory, P. R.	632
Meissner Mfg. Co.	581
National Radio Institute	577
National Union Radio Corporation	583, 632
Nelson Company	637
Onan & Sons, D. W.	625
Opportunity Adlets	638
Popular Homecraft	631

RADIO SCHOOL DIRECTORY

Page 640

Candler System	
Capitol Radio Engineering Institute	
Commercial Radio Institute	
Lincoln Engineering School	
Radio & Television Institute	
RCA Institutes	
Radcrafft Publications, Inc.	615, 627
Radio Corporation of America	584
Sprague Products Co.	613
Sprayberry Academy of Radio	624
Submarine Signal Co.	632
Supreme Publications	621
Supreme Instruments Corp.	626
Sylvania Electric Co.	622
Technifax	631
Triplet	623
University Laboratories	638
Western Electric Co.	632
Weston Electrical Inst. Co.	Inside Front Cover
Wiley and Sons, Inc., John	637

(While every precaution is taken to insure accuracy, we cannot guarantee against the possibility of an occasional change or omission in the preparation of this index.)

BOOK REVIEWS

HOW TO PASS RADIO LICENSE EXAMINATIONS, by Charles E. Drew. Second Edition. Published by John Wiley and Sons. Stiff cloth covers, 7 x 9 3/4 inches, 320 pages. Price \$3.00.

The new edition of this standard book has been awaited by communications students for some seasons. It fulfills all their expectations. Thoroughly revised to meet the new (since the first edition) type of government examinations, it retains the same clear and to-the-point style that distinguished the older issues.

Designed to help the student in answering actual examination questions, the book contains some 1300 questions from the Federal Communications Commission Study Guide, with answers. To provide a more complete treatment, while keeping the answers short and simple, many of the questions are provided with additional explanatory matter, discussions of the questions, or worked-out numerical solutions to calculations. This material is distinguished from the answers themselves by different type.

The new book, in following the sequence of elements in the examination questions, goes back almost to the 1929 (Duncan and Drew) edition in its chapter arrangement. Chapters cover Basic Radio Laws, Basic Theory and Practice, Radiotelephone, Advanced Radiotelephone, Radiotelegraph and Advanced Radiotelegraph, and an Appendix including rules governing commercial operators, extracts from Radio Laws, the Q code, the automatic alarm and a few tables.

The author states that special attention has been given to modulation, oscillators, classes of amplifiers and rectifier power supplies. The good quality paper and typography, as well as the page size, tends to make study easier, and resembles closely the format of the earlier editions.

BASIC RADIO, by C. L. Boltz. Published by the Ronald Press Co. Stiff cloth covers, 5 x 8 inches, 272 pages. Price \$2.25.

Expecting nothing more from his student than that he must know (or learn) a certain amount of common fractions, the author insists that he provide himself with a small cell or bicycle battery, and some pieces of insulated copper and bare steel wire. With such simple apparatus, the heating, magnetic and chemical effects of electricity are demonstrated.

Continuing in the same basic strain, primary and storage cells (accumulators), are next, and a simple handling of Ohm's Law follows. The experimental method is again used to introduce the subject, and a number of measurements and examples make this fundamental formula clear.

The same clear language and simple style is maintained throughout, as is the method of illustrating formulas with examples. The experimental style is also continued as far as it can be applied practically. A sincere attempt is made to cope with the problem of current lead and lag in reactive circuits, so often incomprehensible to the beginner.

The English terms add a quaint touch, though detracting nothing from the clarity of the text.

ELECTRICAL ESSENTIALS OF RADIO, by Morris Slurzberg and William Osterhold. Published by McGraw Hill Book Co. Stiff cloth covers, 5 1/2 x 8 1/2, 529 pages. Price \$4.00.

Designed as a preparatory course for the study of radio and other branches of electronics, this book confines itself to a study of direct and alternating currents in wire circuits, and stops short of such subjects as conduction in gases and vacuum-tube action. The student will find subjects covered in full detail here, which in books dealing mainly with radio are hurried over to reach the main objective.

The level is that of the early high-school pupil. The student is taught such mathematics as may be necessary while handling the actual problems at hand. There is, however, no attempt to over-simplify, and the student learns—among other things—to handle vectors and to calculate impedances of parallel alternating-current circuits.

The chapters on inductance, capacitance, alternating current and resonance are considerably longer than in most parallel radio texts, and there is an opportunity for clearer and more detailed exposition of these subjects. Numerical examples are freely used to insure a thorough understanding of each.

Filter circuits is another subject to which a large amount of space is given, though the calculation of filters is left to more advanced courses.

A special feature of the book is the large number of problems at the end of each chapter. Illustrations are excellent and numerous. The large appendix, which includes symbols and abbreviations, common formulas (including all the equations introduced in the body of the book) and various tables, will also be found useful.

MAINTENANCE AND SERVICING OF ELECTRICAL INSTRUMENTS, by James Spencer. Edited by Major M. F. Behar. The Instruments Publishing Co., Inc. Stiff cloth covers, 5 x 8 inches, 256 pages. Price \$2.00.

The author, who was for fifteen years in charge of the Instrument and Relay Department of the Meter Division of Westinghouse at Newark, N. J., not only knows his subject, but is able to get his knowledge of the subject across to the reader. This ability is in part explained by the "ten years of teaching evening classes in Northern New Jersey," referred to in the preface. He has been ably assisted by Major Behar, Editor of *Instruments*, in which publication the book first appeared as a serial. Major Behar has even added a chapter of his own, on *Pivots and Bearings*, and has inserted notes on simple repairs in a number of places.

While the direct-current moving-coil type of instrument so important to the radio and electronic worker is forced to take its place with numerous others, and is dealt with in the first thirty-three pages; even this space contains more information on meter servicing than has been available up to the present, and will without doubt be welcomed. Thermocouples and meter rectifiers are also mentioned in the same chapter.

Other types handled are A.C. ammeters and voltmeters, wattmeters, frequency meters and synchrosopes, power factor meters and reactive factor meters. There is an interesting chapter on Dial Marking, and short chapters on plug-in or detachable instruments and damping means, as well

(Continued on following page)

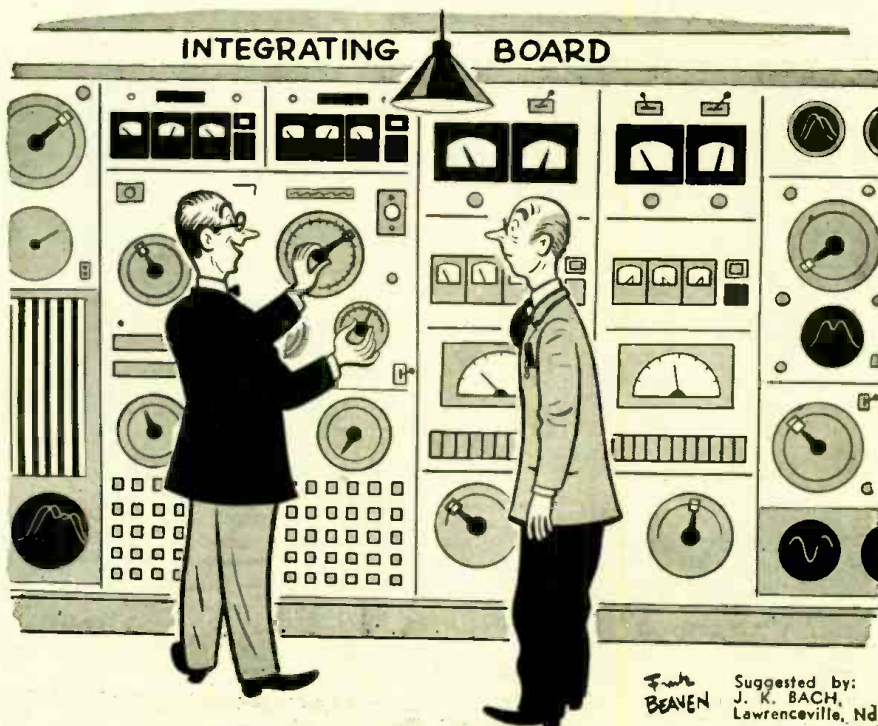

"It used to work calculus, but I rewired it to make up alibis for the little woman."

RADIO SCHOOL DIRECTORY

TO OUR READERS—NOW IS THE TIME TO TAKE UP RADIO!

NOW, more than ever before America needs trained radio men. The Army, the Navy and the Air Force are continuously on the lookout for men who have had training in radio. Scores of war industries require radio men in various capacities throughout the country. There now is and there will be a great shortage of radio men for years to come. Reputable schools of Radio advertise to help you.

... Here's How You Can Qualify for a BETTER RADIO JOB!

... CREI technical training is preparing others for good-paying radio jobs—WHY NOT YOU?

Are you finding yourself in a routine job—a job that any other man can handle just as well as you? Today, radio JOBS are many—but radio CAREERS are few! Now is the opportune time for you to equip yourself with the necessary technical training to qualify for an important engineering position with a sound future.

NOW when industry needs men, is the time for you to investigate radio career training. Your radio experience backed by modern CREI technical training will equip you to share in the good-paying jobs that await trained men—and to make good in the important positions that lead to post-war careers of security and happiness!

WRITE TODAY! If you are a professional or amateur radio man and want to make more money—let us prove to you we have something you need to qualify for the better job opportunities that can be yours. To help us intelligently answer your inquiry—please state briefly your education, radio experience and present position.



CAPITOL RADIO ENGINEERING INSTITUTE

Dept. RC-7, 3224 16th St., N. W., Washington 10, D. C.

RADIO TECHNOLOGY

RCA Institute offers an intensive two-year course of high standard embracing all phases of Radio and Television. Practical training with modern equipment. Also shorter specialized courses in Commercial Radio Operating, Radio and Television Servicing, and Aviation Communications. For Free Catalog write Dept. RC-44.

RCA INSTITUTES, Inc.
A Radio Corporation of America Service
75 VARICK STREET NEW YORK 13, N. Y.

Correspondence Courses in RADIO and ELECTRICAL ENGINEERING

ELECTRICAL ENGINEERING Get good grasp of wide electrical field. Prepare yourself, at Low Cost, for secure future. Modern, simplified, you can understand quickly.
RADIO ENGINEERING Extra fine course in radio, publishes you to be super-service man, real vacuum tube technician. Servicemen needed badly. Diploma on completion. Tuition \$25, either course. Deferred payment plan. Get copies of school catalogs, student magazines, complete details. **SEND NOW!**
FREE
LINCOLN ENGINEERING SCHOOL Franklin Stn., Box 61-C65 WASHINGTON, D. C. (Formerly at Lincoln, Nebr.)

(Continued from previous page)

as a list of instrument tools which should be useful to the beginner in this type of servicing.

The discussion of underlying principles of various meter types, the part the springs play and the detailed treatment of pivots and bearings should also greatly increase the new maintenance man's grasp of the principles of instrument maintenance and enable him to attempt meter servicing with confidence that he will not do the instrument harm rather than good.

This book has been needed, and will doubtless be studied avidly by those who have been faced with the problem of keeping numbers of meters in order.



Send for FREE 52-page Book. It shows that "crack" operators rely on something besides practice to develop their high speeds and proficiency. It explains the "knack" of sound-sense and sound-consciousness—the secret of speedy sending and receiving. Once you acquire these mental processes, reading code becomes almost second nature to you. The Candler System, endorsed by telegraph champions, will train you quickly to be a High-Speed Radio Operator or Amateur. If you want s-p-e-e-d and proficiency—send for this revealing book now.

CANDLER SYSTEM CO. Box 928, Dept. 3G, Denver, Colo., U.S.A.
And at 121 Kingsway, London, W.C. 2, England

RADIO . . . TELEVISION ELECTRONICS

TRAIN NOW for postwar opportunities in this VAST, NEW field! Classes day and evening. Call daily 9-9—Sat. 9-2, or write Dept. RC.

RADIO-TELEVISION INSTITUTE
480 Lexington Ave. (46th St.), New York, N. Y.
PLaza 3-4585 Licensed by N. Y. State

COMMERCIAL RADIO INSTITUTE

A radio training center for twenty-four years.

RESIDENT COURSES ONLY

Pre-Induction, Broadcast, Service, Aeronautical and Radio telegraphy classes now forming for fall term Oct. 9. Literature upon request.

Dept. C., 38 West Biddle St., Baltimore 1, Md.

★ BUY WAR BONDS ★

ANSWERS TO ELECTRONICS QUIZ ON PAGE 600

- 1—Electronic diffraction pattern of gold. (G. E. Photo)
- 2—A 100,000-watt Westinghouse transmitting tube. (Westinghouse Photo)
- 3—A "random noise" test for microphones, designed to pick up the noise due to molecular bombardment of the air. (RCA Photo)
- 4—A 1/1,000,000th second photograph of smoke blowing through an electric fan. (G. E. Photo)
- 5—Focussing a television camera in the CBS studio. (CBS Photo)
- 6—A Westinghouse industrial oscilloscope in use checking arrestor performance under surges. (Westinghouse Photo)
- 7—It's a sound-proof box used in studying pickups. The shape eliminates trouble from sound reflections. (RCA Photo)

CATHODE-RAY TUBES

(Continued from page 605)

Another method consists of using a sine wave sweep in which case a trapezoid pattern will result. From the first of the patterns discussed before we saw how a straight line results when the two inputs are sine waves in phase and of equal frequency. Since a modulated radio wave possesses simultaneous positive and negative audio envelopes two symmetrical straight lines will result. We therefore have a trapezoid with an interior made of fine vertical lines (R.F.). For 100% modulation the trapezoid becomes a triangle.

Oscilloscopes are useful in checking wave form from stage to stage in order to localize distortion. Adjustments may be made to amplifiers while the scope is left on so that optimum results may be visible. These adjustments may be made with regard to selectivity, sensitivity, overload, flat-top, noise or alignment requirements.

The fact that an oscilloscope responds simultaneously to two voltages gives it a unique importance. For example, it may be used to show balance of a bridge which ordinarily requires two different adjustments, one for the resistive and the other for the reactive component. Similarly, it is possible to make visible tube characteristics (E_k vs. I_p) and BH curves.

The cathode-ray tube as generally used is constructed with electro-static plates as described. However, some purposes make use of electro-magnetic deflection. Electrons are deflected when a magnet is brought near the tube, as the user may check. For this type of deflection, coils are so placed outside the envelope that they act on the moving electron stream.

Advantages of this type of scope are that the tube may be made smaller, more rugged and less costly. On the other hand, the inductive effects are troublesome and power is taken from the deflecting voltage.

Oscilloscope tubes require a high accelerating voltage—usually over 1000 volts—so that care must be exercised when handling them. It is general practice to ground the positive side of the power supply, so that the danger points are cathode and grid. Focussing electrodes generally require 25% of the second anode voltage.

Cathode-ray tubes are available from the small 1" size (913) up. The 5" size tube is generally used for laboratory design and repair. Caution must be used to prevent damage to the screen by leaving an intense spot on the screen for a time. With a reasonable amount of care, the scope will have a long life of useful service.

8—The pipes are resonating tubes, capable of producing sounds that would split the human ear-drum. It's used for testing microphones. (RCA Photo)

9—An electronic induction heater, used by RCA to solder terminals on transformers. (RCA Photo)

10—It is simply a General Electric time interval meter. (G. E. Photo)

11—These are large coils used in conjunction with an induction electron accelerator. (G. E. Photo)

12—Bacon and eggs is the dish. They are cooking on a sealed-beam headlamp from an Army bomber, which provides plenty of heat. (Westinghouse Photo)

If you feel like scoring yourself on this quiz, allow 5 points for each correct answer. Twenty points is average, 30 excellent, and anything over 40 points extraordinary!

FOIL THE SABOTEURS



Give critical plants the protection of Browning Signal System with its balanced-capacitance electronic circuit, which saturates vulnerable areas and releases guards for productive duty. Pre-

Pearl Harbor installations have proved efficient, dependable, economical.

Browning Frequency Meters are accurate to .005%. Pre-check public utility and other emergency radio systems. Assure signal clarity.

ILLUSTRATED LITERATURE UPON REQUEST



BROWNING
LABORATORIES, INCORPORATED
WINCHESTER, MASSACHUSETTS



Audels RADIOMANS GUIDE

1001 RADIO FACTS AND FIGURES

772 PAGES · 400 DIAGRAMS, CHARTS AND PHOTOS

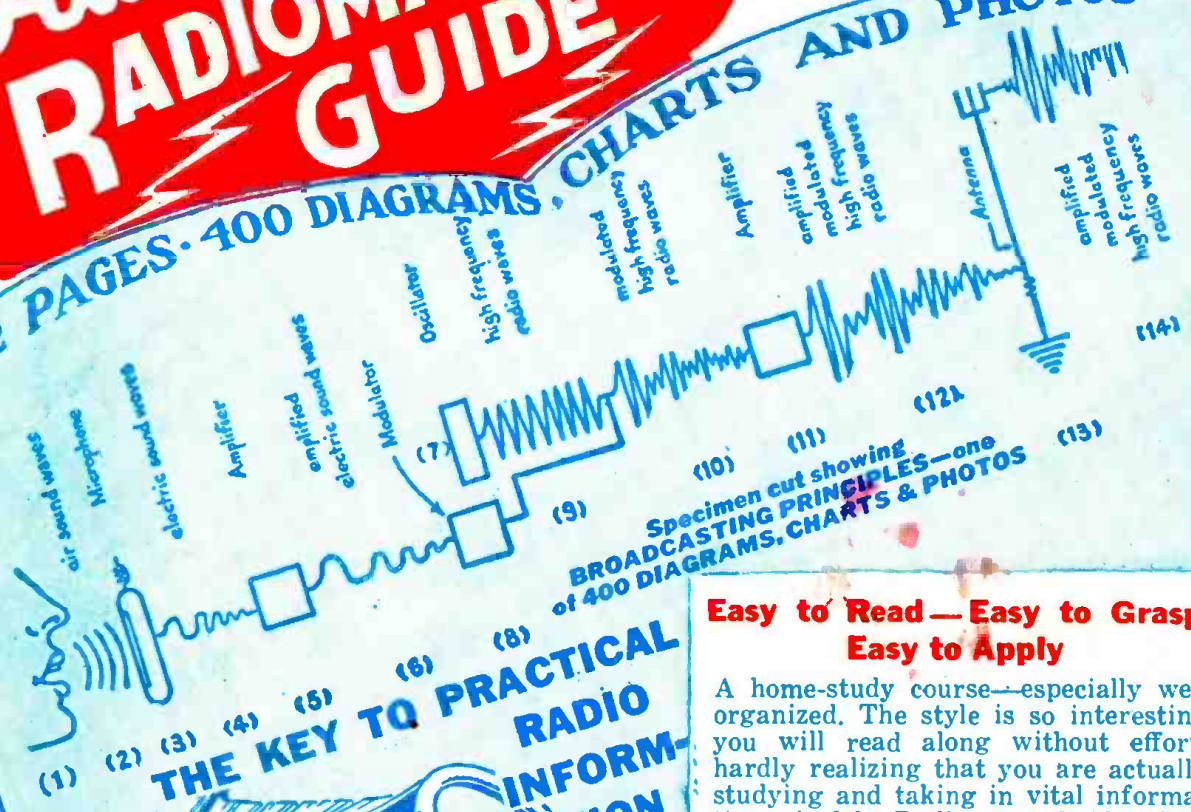

THE KEY TO PRACTICAL RADIO INFORMATION

It gives you in usable form pointers on radio, including frequency modulation, television, etc. Also valuable inside information for Aviators, Marines, Commercial Operators and Technicians, Servicemen and Students.



**Q AND A
UNIQUE
QUESTION
and
ANSWER
METHOD**

Highly Endorsed

**Easy to Read—Easy to Grasp
Easy to Apply**

A home-study course—especially well organized. The style is so interesting you will read along without effort, hardly realizing that you are actually studying and taking in vital information. Audels Radiomans Guide gives you just the right amount of mathematics required to cope with radio problems successfully. You can solve, practically every radio problem that comes up. At your finger tips is a complete index for instant use.



A COMPLETE LIBRARY IN ONE BOOK

AUDELS RADIOMANS GUIDE gives authentic Principles and Practices in Construction, Operation, Service and Repairs. Covers clearly and concisely radio fundamentals—Ohm's Law—Physics of sound as related to radio science—Measuring instruments—Power supply—Resistors—Inductors—Condensers—Transformers and examples—Broadcasting stations—Radio Telephony—Receivers—Diagrams—Construction—Control Systems—Loudspeakers—Antennas—AutoRadio—Phonograph Pick-ups—Public Address Systems—Aircraft and Marine Radio—Radio Compass—Beacons—Automatic Radio Alarms—Short Wave—Coil Calculations—Testing—Cathode Ray Oscillographs—Static Eliminations—Trouble Pointers—Underwriter's standards—Units and tables. REVIEW QUESTIONS—READY Reference Index.

17 DAYS' FREE TRIAL

\$4 COMPLETE

PAY \$1 ONLY

1 MO.

THEO. AUDEL & CO., Publishers
49 West 23rd Street, 10, New York

Mail AUDELS NEW RADIOMAN'S GUIDE for free examination. If O.K. I will send you \$1 in 7 days; then remit \$1 monthly until \$4 is paid. Otherwise I will return it.

Name _____
Address _____
Occupation _____
Reference _____

MAIL THIS COUPON TODAY